

BCA Series, 3000 Watt

12V Bi-Directional DC/DC Converter



The 3,000 Watt 48S12.3K0BCA Bi-directional non-isolated DC/DC converter provides a complete solution for in-vehicle power distribution with 12V/48V battery configurations for a variety of applications including micro and mild hybrid automotive systems. The bi-directional DC/DC converter charges a low side (12V) battery during normal operation (buck mode) and charges or assists the high voltage (48V) battery in emergency situations (boost mode). The bi-directional DC/DC converter operates more as an ideal current source with variable direction, thus allowing energy transfer between two voltage domains. Voltage feedback maintains the output voltage within the acceptable operating range and eventually allows a custom charging profile for the battery pack. It regulates the average current flowing between the high voltage and low voltage ports in the direction selected via CAN interface. It is packaged in an unprecedented low profile 8.67" x 6.14" x 1.008" mechanically enclosed package weighing only 3.04 lbs. The package makes the unit ideal for harsh shock and vibration requirements as well as easy integration with a battery pack. Three M8 bushings are provided two for power connection and two for ground connections.

Features

- Automotive 12V/48V Battery System
- Buck, boost and precharge modes of operation
- Low Side (LS): 12V Input Voltage Range: 6V to 18V
- High Side (HS): 48V Input Voltage Range: 24V to 58V
- Overcurrent, Overvoltage, & Over-temperature Protection. All protections are latching.
- Disconnect switch LS (12V) and HS (48V)
- Reverse polarity protection
- Constant Voltage and Constant Current Mode
- Average Current Mode Control
- Custom Charging Profile for the Battery Pack
- LS and HS Current Monitoring
- Internal temperature monitoring
- High power density
- Low profile 1"
- Efficiency up to 96.5%
- Dimensions 8.67" x 6.14" x 1.008"
- Weight 3.04 lb (1.38 Kg)
- Excellent thermal performance
- Constant switching frequency
- CAN 2.0b Interface including remote ON/OFF
- Good shock and vibration damping
- Highly Integrated Solution
- RoHS Compliant

Table of Contents

Operational Overview..... 2

Functional Features..... 3

Electrical Specifications 4

CAN Functions 8

Operational Notes..... 9

Test Configuration..... 12

Characteristic Curves..... 13

Mechanical Specification..... 14

Operational Overview

48S12.3K0BCA

Input Voltage Range [V]				Output current [A]		Output Power W]		Efficiency [%] @ FL	
12V In		48V In		Buck	Boost	Buck	Boost	Buck	Boost
Min	Max	Min	Max	Max	Max	Max	Max	Typ	Typ
7	18	24	58	250	83	3000	3000	95.5	95.3

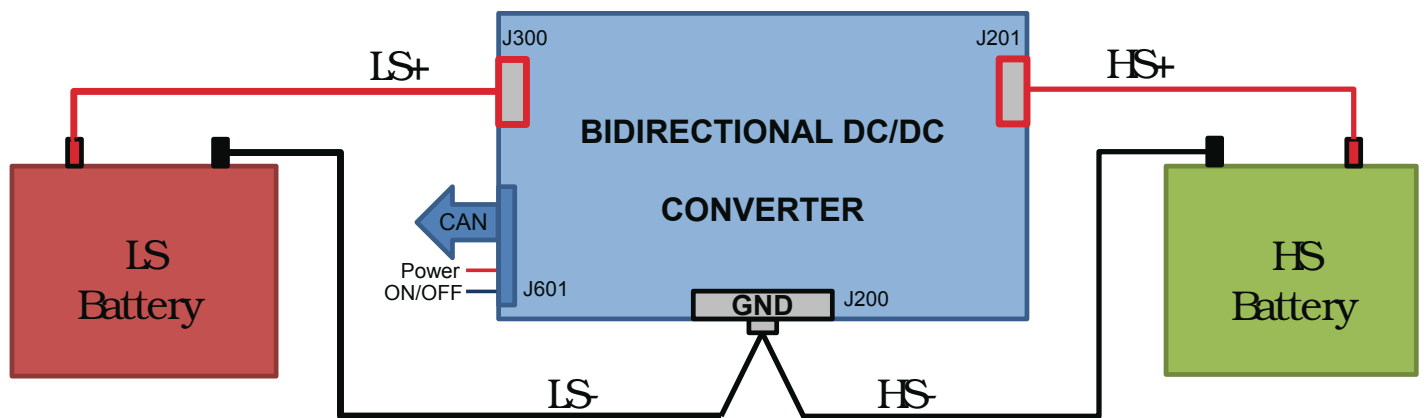

The 48S12.3K0BCA block diagram.

The 48S12.3K0BCA integrates a non-isolated four phase DC/DC converter for bi-directional current flow between two batteries (LS = 24V and HS = 48V), a disconnect switch on low side, and a CAN interface with five connections:

1. **Low Side Positive (LS+) Connector – J300:** M8 threaded press-fit bushing (WE 7460717).
2. **High Side positive (HS+) Connector – J201:** M8 threaded press-fit bushing (WE 7460717).
3. **GND Connector – J201** Common GND for LS and HS. M8 threaded press-fit bushing (WE 7460717).
4. **CAN Interface Connector – J601:** Signal connector for the CAN interface, ON/OFF signal and power connection for powering the high speed CAN-Transceiver with BUS Wake-up and microcontroller inside the converter. Power connection has reverse polarity protection and is required for proper operation of the converter.



BCA Series, 3000 Watt

12V Bi-Directional DC/DC Converter

Functional Features

The 48S12.3K0BCA is fully controlled via CAN interface. It uses a high speed CAN-Transceiver (TLE7251VSJ) for communication with the microcontroller. It provides control of the PWM control ICs, and protection and monitoring of the current and temperature monitoring features. The converter operates in buck, boost and pre-charge mode.

The 48S12.3K0BCA includes a disconnect switch based on a back to-back N MOSFET configuration for both low side (12V battery) and high side (48V battery). The converter has reverse voltage protection, short circuit protection as well as low standby current. The design includes a CAN 2.0b interface for complete control of the converter as well as monitoring LS and HS voltage and current and internal temperature of the converter. The 48S12.3K0BCA is designed to operate in wide operational temperature range. Through holes in the base plate are provided to allow easy mounting or the addition of a heatsink or cooling plate for extended temperature operation.

The converter's high efficiency and high power density are accomplished through the use of high-efficiency synchronous rectification technology, advanced electronic circuitry, and leading edge packaging and thermal design. This results in a highly reliable product. The diode emulation mode of the synchronous rectifiers prevents negative currents, but also enables discontinuous mode operation for improved efficiency with light loads. The converter operates at a fixed frequency and follows conservative component de-rating guidelines.



BCA Series, 3000 Watt

12V Bi-Directional DC/DC Converter

Electrical Specifications

Conditions: $T_A = 25\text{ °C}$, Airflow = 200 LFM (1.0 m/s), $V_{in} = 48\text{VDC}$, unless otherwise specified. Specifications are subject to change without notice.

48S12.3K0BCA					
Parameter	Notes	Min.	Nom.	Max.	Units
Absolute Maximum Ratings					
Input Voltage					
High Side (48V)	Continuous	0		58	V
	Load Dump	0	70	75	V
Low Side (12V)	Continuous	-36		42	V
	Load Dump			58	V
Operating Temperature	Baseplate (100% power)	-40		100	°C
Storage Temperature		-55		125	°C
Isolation Characteristics and Safety					
Isolation Voltage	Input to Baseplate & Output to Baseplate	250			V
Feature Characteristics					
Fixed Switching Frequency – Multiphase converter	Each phase		175		kHz
	Total 4 phases		700		kHz
TEMP monitor	PCB temperature	-40°C		+125	°C
	Accuracy	-2	1	+4	%
All Protections latching					
Over-temperature Shutdown	PCB Temperature – Fixed and Latching	114	120	126	°C
ON/OFF Remote Control – Positive Logic					
ON state	Pin voltage	8			V
OFF state		7			V
CAN Baud Rate			500		Kbps
Thermal Characteristics					
Thermal resistance Baseplate to Components	At Full Load		15		°C



BCA Series, 3000 Watt

12V Bi-Directional DC/DC Converter

Electrical Specifications Buck Mode

Conditions: $T_A = 25\text{ }^\circ\text{C}$, Airflow = 200 LFM (1.0 m/s), $V_{in} = 48\text{VDC}$, $V_o = 13.8\text{V}$ unless otherwise specified. Specifications are subject to change without notice.

48S12.3K0BCA – BUCK MODE					
Parameter	Notes	Min.	Nom.	Max.	Units
High Side (Input) Characteristics					
Operating Voltage Range		24	48	58	V
Under Voltage Lockout	Latching				
Turn-on Threshold	Default		24.9		V
Turn-off Threshold	Default		23.4		V
	Programmable	22.5		52	V
Lockout Hysteresis Voltage	Default		1.5		V
Overvoltage Protection	Default			56	V
	Programmable	24		58	V
Maximum High Side Current	VHS = 36V, VLS=12V, ILS=250A (3000W)		87.0		A
	VHS = 48V, VLS=12V, ILS=250A (3000W)		65.5		A
Stand-by Current	Converter Disabled		100		μA
Output (Low Side) Characteristics					
Overvoltage Protection	Default value		20		V
	Programmable	6		20	V
Undervoltage Protection	Default		5.4		V
	Programmable	5.4		20	V
LS Stand-by Current	Converter Disabled and in hibernation		30		μA
Constant Voltage Mode					
Output voltage range	Programmable via CAN interface ²	6		16	V
Output Voltage Set Point Accuracy	At 10A load current		± 1		%
Constant Current Mode					
Output Current Range/Overcurrent Protection	Programmable via CAN interface (ISET)	1		250	A
Output Current Regulation	12.5A < Load Current < 125A		± 1		%
Output Current Set Point Accuracy	12.5A < Load Current < 125A		± 1		%
Low Side Current Monitor (Read back)	12.5A < Load Current < 125A		2		%
High Side Current Monitor (Read abck)	7A < IHS < 65A		± 1		%
Efficiency					
ILS = 107 (1500W) ¹	$V_{in} = 48\text{V}$, $V_o = 14\text{V}$	95.5	96.3	97.0	%
ILS = 215A (3000W) ¹	$V_{in} = 48\text{V}$, $V_o = 14\text{V1}$	94.7	95.5	96.3	%

1) Voltages measured at converter terminals.

2) Output (HS) voltage is always > Input (LS) voltage



BCA Series, 3000 Watt

12V Bi-Directional DC/DC Converter

Electrical Specifications Boost Mode

Conditions: $T_A = 25\text{ °C}$, Airflow = 200 LFM (1.0 m/s), $V_{in} = 13.8\text{VDC}$, $V_o = 48\text{V}$ unless otherwise specified. Specifications are subject to change without notice.

48S12.3K0BCA – BOOST MODE					
Parameter	Notes	Min.	Nom.	Max.	Units
Low Side (Input) Characteristic					
Operating Voltage Range		9	12	16	V
Under Voltage Lockout	Latching				
Turn-on Threshold	Default		5.9		V
Turn-off Threshold	Default		5.4		V
	Programmable	5.4		16	V
Lockout Hysteresis Voltage	Default		0.5		V
Overvoltage Protection	Default			20	V
	Programmable	6		20	V
Maximum Low Side Current	VLS = 12V			250	A
Stand-by Current (Converter disabled)	VHS > VLS (buck or boost)		50		μA
	VHS < VLS (precharge mode)		100		μA
High Side (Output) Characteristics					
Overvoltage Protection	Default value		56		V
	Programmable	24		58V	V
Undervoltage Protection	Default	23.4			V
	Programmable	22.5		52	V
Stand-by Current	Converter Disabled and in hibernation		TBD		μA
Constant Voltage Mode					
Output voltage range	Programmable via CAN interface ²	24	48	54	V
Output Voltage Set Point Accuracy	At 3A load current		± 1		%
Constant Current Mode					
Output Current Range LS current	Programmable via CAN interface (ISET)	1		250	A
Output Current Regulation			1		%
Output Current Set Point Accuracy	At ILS = 37A		7.5		%
	At ILS = 74A		2.7		%
Low Side Current Monitor (Read back)	25A < ILS < 250A		2		%
High Side Current Monitor (Read back)	7A < IHS < 62.5A		± 1		%
Efficiency					
IHS = 31.5A (1500W)	$V_{in} = 14\text{V}$, $V_o = 48\text{V}^1$	95.5	96.4	97.1	%
IHS = 62.5A (3000W)	$V_{in} = 14\text{V}$, $V_o = 48\text{V}^1$	94.5	95.3	96.0	%

1) Voltages measured at converter terminals.

2) Output (HS) voltage is always > Input (LS) voltage



BCA Series, 3000 Watt

12V Bi-Directional DC/DC Converter

Environmental and Mechanical Specifications. Specifications are subject to change without notice.

General Parameters					
Parameter	Note	Min.	Nom.	Max.	Units
Environmental					
Operating Humidity	Non-condensing			95	%
Storage Humidity	Non-condensing			95	%
ROHS Compliance ¹	See Calnex Website http://www.calnex.com/pdf/ROHS.pdf for the complete RoHS Compliance statement				
Shock and Vibration	Designed to meet MIL-STD-810G for functional shock and vibration.				
Water washability	Not recommended for water wash process. Contact the factory for more information.				
Mechanical					
Weight			3.034		Lbs.
			1.376		Kg
Power Terminal (Tread height)			1.18		Inches
Material		Brass			
Surface		Tin			
Tightening Torque		8.85 in/lbs			
Rated Current	Low Side	250 A			
External Thread		M8			
Case Dimension	Not including M8 terminals	8.67 x 6.14 x 1.008"			Inches
		220.22 x 155.96 x 25.6			mm
Height	Including M8 terminals	1.24			Inches
		31.50			mm
Cover	Material	0.25 in. THK Steel			
	Finish	Powder Coat, Black			
Baseplate	Material	Aluminum			
	Flatness	-0.005		+0.005	Inches
		-0.125		+0.125	mm

Additional Notes:

1 The RoHS marking is as follows 



BCA Series, 3000 Watt

12V Bi-Directional DC/DC Converter

CAN Functions

The following functions are fully controlled via CAN interface:

- ON/OFF
- Current and voltage set points
- Current direction
- Protection threshold: Undervoltage, Overvoltage and Overtemperature

In addition, the 48S12.3K0BCA provides low side current monitoring and internal PCB temperature monitoring.

High speed CAN-Transceiver (TLE7251VSJ) is employed for communication between the CAN interface and the microcontroller inside the converter. The converter requires both voltages to be present, the high side and low side voltages must be inside the specified range, in order to operate.

All protective functions are latching and reset can only be accomplished via the CAN interface. The converter has default limits (minimum and maximum) for current and voltage set points as well as for undervoltage, overvoltage and overtemperature thresholds. Note that the threshold for all protective features can be programmed via CAN, as long as the programmed value is inside the default limits (See spec). The converter will shut down and latch if the set points (voltage and current) and thresholds for all protections are set outside of the default limits.

Contact the factory for CAN interface: Command and Status Message.

The 48S12.3K0BCA regulates the average current flowing between the high voltage and low voltage ports in the direction specified by the DIR signal. It is designed to operate in constant current mode (CCM) or constant voltage mode (CVM). In the constant current mode, the low side current is programmed and regulated regardless if the converter is in buck or boost mode. When operated in the constant voltage mode, the programmed current (ISET) has to be greater than the actual LS current.

The direction of the current can be changed on the fly, in which case the converter will reduce the LS current to zero and start in different mode (reversing the current direction) with a time delay of 30 msec (typ.) as shown in Figs. 15-16. Note that ISET needs to be inside the default limits for the given mode of operation (See Specification).

The 48S12.3K0BCA includes a disconnect switch based on a back to-back N MOSFET configuration for both the low side (+12V battery) and high side (+48V battery) and has reverse voltage protection, overcurrent, short circuit protection as well as low standby current for the low side.

Note: External power and ON/OFF (high level) are required to provide initial power to CAN interface IC and microcontroller inside the converter. Internal control circuit has a separate bias derived from the High Side Voltage. If the external power is removed and/or ON/OFF is pulled low during regular operation of the converter, Can communication will be interrupted and converter will turn-off and latch.



BCA Series, 3000 Watt

12V Bi-Directional DC/DC Converter

Operational Notes

Input Fusing

The 48S12.3K0BCA converter provides an electronic disconnect switch based on back-to-back 40V rated N MOSFETs on the low side and 100V rated N-MOSFETs on the high side.

Reverse Voltage Polarity Protection

The 48S12.3K0BCA converter has input reverse polarity protection on both low side (12V battery) and high side (48V battery).

Undervoltage Protection

For proper operation, it is required to have voltage present on both the HS and LS terminals. The 48S12.3K0BCA converter monitors the high side and low side voltages and will start and regulate properly only if both voltages exceed the corresponding Turn-on thresholds (See Specification) and remain at or above Turn-on threshold. The converter will turn-off when either of the two voltages drop below their corresponding Turn-off threshold (See specification), and will latch off. The built-in hysteresis prevents the converter from shutting down at the low input voltage near the Turn-on threshold. The converter can be restarted only via CAN interface once both voltages are above their Turn-on thresholds and the ON/OFF pin is in logic level high state. Note: the undervoltage circuit has hysteresis only for the high side voltage when the converter operates in the buck mode and for low side voltage when the converter operates in the boost mode. Once the undervoltage threshold is reached, the converter shuts down and latches off. The user should take into account the voltage drop due to resistive ($I \cdot R$) and inductive voltage drops in the power lines to make sure the voltage at the converter's terminals is always above the Turn-off threshold level under all operating conditions.

If the values for the undervoltage protection are not provided via the CAN interface, the converter will use default values (See spec).

Contact factory for option with precharge mode when converter operated in boost mode.

Input Source Impedance

Because of the switching nature and negative input impedance of DC/DC converters, the input of these converters must be driven from the source with both low AC impedance and DC input regulation.

The low profile of the 48S12.3K0BCA converter is optimized for a power source cable length of 4m (13 ft) for High Side battery and up to 4m (13 ft) for low side battery.

The DC input regulation, associated with the resistance between the input power source and the input of the converter, plays a significant role in low input voltage applications such as 12V battery systems.

Note that the input voltage at the input terminals must never decrease below the Turn-off threshold under all load conditions during operation.

ON/OFF (J601 – pin 3)

The ON/OFF pin is used in conjunction with the CAN interface and needs to be in the active state (logic level high $> 8V$) in order to enable the converter via CAN interface.

Switching voltage level on the ON/OFF pin from high to low $< 6V$) or shorting to GND will shut down and latch the converter. Switching the ON/OFF voltage from logic low to logic high will not enable the converter until the next command for enabling the converter via CAN interface is generated.

Constant Current Mode and Direction Select

The converter operates as an ideal current source with variable direction when the output voltage is lower than the voltage specified by the CAN interface. This configuration allows energy transfer between the two voltage domains (batteries). Only the low side domain current is directly programmed and regulated in both modes of operation (buck and boost). The current can be programmed in the range of $I_{SET} = 1A-250A$. The converter has an internal soft start for I_{SET} to reduce inductive voltage drop in the power cables (See Figs. 11-14) during both turn-on and turn-off. The converter will not operate if $I_{SET} = 0$ or it is outside the limits. Current level I_{SET} can be changed on the fly.

The direction of the current can be changed dynamically during operation. In that case, the converter will shut down and change the mode of operation through the internal soft start thus eliminating surge current during the direction change (See Figs.15-16).

Pre Charge Mode

The converter supports HS (48V) to be precharged from the LS bus. During this mode of operation, undervoltage protection on the HS is disabled for 200msec thus allowing to start into high capacitance if required.



BCA Series, 3000 Watt

12V Bi-Directional DC/DC Converter

Current Monitoring

The converter provides LS and HS current monitor read back value via CAN interface. It has a positive value when converter operates in buck mode and a negative value when converter operates in boost mode.

Constant Voltage Mode

When the load current is lower than the programmed current, ISET, the converter will operate in the voltage mode regulating the output voltage at the level set by the CAN interface. The range of both voltages is provided in the specification table. The converter will not operate if the voltage level programmed via the CAN interface is outside the range. If the load current exceeds the ISET current level, the output voltage will reduce and the converter will enter the constant current mode regulating the low side current.

Output Overcurrent Protection(OCP)

The converter senses both LS and HS currents. Average LS current is limited at ISET level when converter operates in constant current mode. Additional protection on the LS is provided by cycle by cycle peak current limit. Low side (Inductor current) is monitored and limited to the current level set by the CAN interface (ISET =1A-150A). HS current is also monitored and provides additional protection at typ. $\pm 96A$ in case of overload or short circuit. Once OCP threshold is tripped, internal logic disconnects converter from both, LS and HS batteries via corresponding disconnect switches.

Buck Mode

If the load current increases above the maximum limiting level, the converter enters constant current mode of operation and the low side voltage (output voltage) will be reduced. When it drops below the turn-off threshold for the low side terminal (12V), the undervoltage protection will be activated and the converter will shut down, turn-off the disconnect switch and latch off.

The converter can only turn-on via the CAN interface. Note: the converter will not start if the low side voltage is below the turn-on threshold so a startup into a shorted low side is prevented.

Boost Mode

In the boost mode, the output current on the high side terminal is indirectly limited by the inductor (LS) current. If the load current increases above the maximum limiting level defined by ISET, converter operates in constant current mode and the high side voltage (output voltage) will be reduced. When it drops below the turn-off threshold for the high side terminal (48V), the undervoltage protection will be activated and the converter will shut down, turning off both the low side and the high side disconnect switches and latch off.

The converter can only turn-on via the CAN interface. Note: that the converter will not start if the high side voltage is below the turn-on threshold so that startup into a shorted high side is prevented.

Output Overvoltage Protection(OVP)

The converter will shut down if either of the terminal voltages (low side or high side) is above their corresponding thresholds of the OVP circuitry. Once the converter has shut down, it will remain latched off. Overvoltage thresholds can be programmed via the CAN interface, but must be inside the limits provided in the spec table. If the CAN command requires an OVP threshold above the max limit set internally, the converter will shut down and remain latched.

Over-temperature Protection(OTP)

The 48S12.3K0BCA converter has two levels of over temperature protection. The first level provides a voltage proportional to the average PCB temperature and this signal can be used by end user to either adjust the operation of the converter (e.g. reduce current) or set a disable for the converter when the temperature reaches a predetermined level. The second level of over temperature protection is provided by temperature switches with a fixed threshold of typ 120°C. It will be activated if OTP set by user is above 120C. The converter will shut down when the temperature exceeds 120°C. The temperature threshold hysteresis is typically 10°C.

Once the over temperature protection is tripped, the converter will shut down and latch off. Restarting the converter requires an enable from the CAN interface.



BCA Series, 3000 Watt

12V Bi-Directional DC/DC Converter

Thermal Consideration

The 48S12.3K0BCA converter can operate in a variety of thermal environments. However, in order to ensure reliable operation of the converter, sufficient cooling should be provided. The 48S12.3K0BCA converter has a base plate with through holes on the side to allow easy mounting or addition of a heatsink, or base plate for extended temperature operation.

The metal cover on the top of the converter is not used for cooling as it serves as protection for the components on the PCB. In order to improve the thermal performance, the power components inside the unit are thermally coupled to the baseplate. In addition, the thermal performance of the converter is enhanced by use of the power terminals. Heat is removed from the converter by conduction, convection and radiation. In order to achieve the required

performance, several factors such as ambient temperature, airflow, power dissipation, converter orientation, (how the converter is mounted), that need to be taken into account

It is highly recommended to measure the temperature in the middle of the baseplate, in each particular application to ensure that proper cooling of the converter is provided.

A reduction in the operating temperature of the converter will result in an increased reliability.

Thermal Derating

The converter is cooled entirely via the base plate, and partially via power terminals (J200, J201, J300) and power cables connected to the batteries. Note that converter can deliver full power (3kW) as long as base plate temperature does not exceed 100 C.

Test Configuration

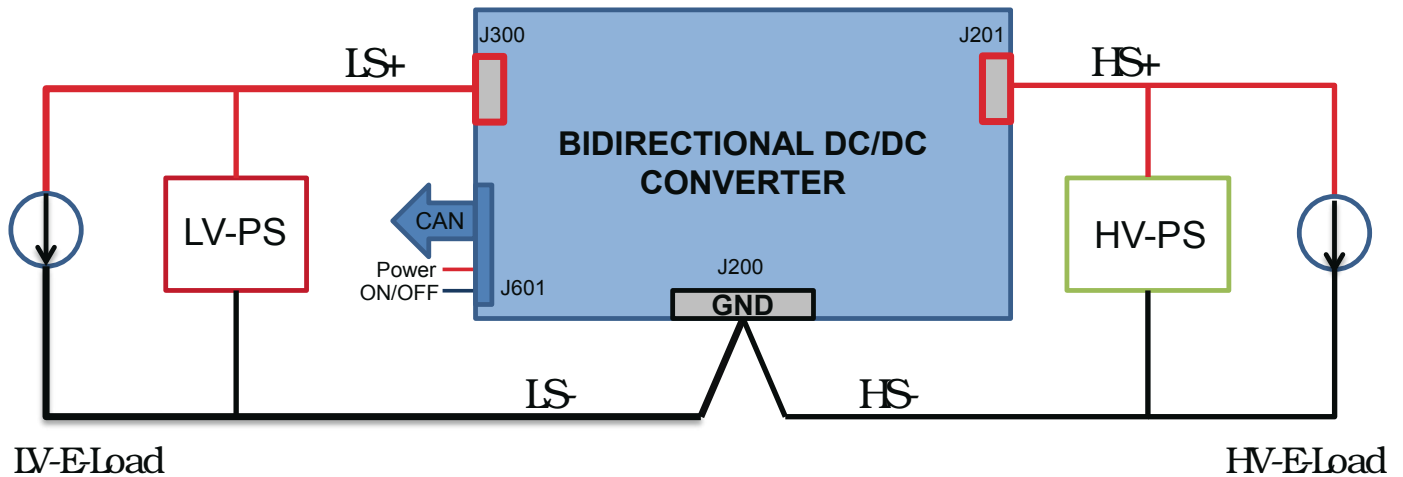

Fig. 2: The bench setup used to operate 48S12.3K0BCA and take measurements provided in data sheet. The combination of the Electronic Load (E-Load) and Bench Power Supply (PS) emulates a battery capable of both sourcing and sinking current.

For testing converter in constant current mode:

Buck Mode:

- LV-PS needs to be set at a lower value than VSET by the CAN interface and be able to provide current to support LS-E-Load current.
- LS-E-Load needs to be set to have current higher (10% - 20%) than ISET by the CAN interface.
- HV-PS should be capable of providing maximum required power.
- HV-E-Load is not required.

Boost Mode:

- HV-PS needs to be set at a lower value than VSET by the CAN interface and be able to provide current to support HS-E-Load current.
- HS-E-Load needs to be set to have current higher (10% - 20%) than ISET by CAN interface.
- LV-PS should be capable of providing maximum required power.
- LV-E-Load is not required

Direction change:

- LV-PS and HV-PS need to be set at a lower value than VSET by the CAN interface and be able to provide current to support LS-E-Load and HS-E-Load current, respectively.
- LS-E-Load and HS-E-Load need to be set to have current higher (10%-20%) than ISET by CAN interface.

Characteristic Curves — Efficiency and Power Dissipation in Buck and Boost Mode

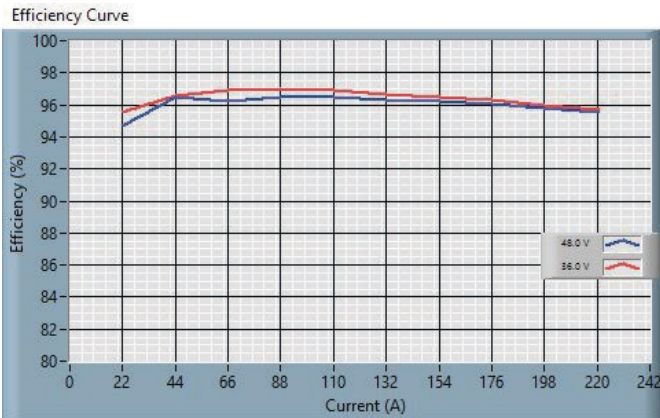

Fig. 1: 48S12.3K0BCA Efficiency Curve – Buck Mode, $V_o=14V$.

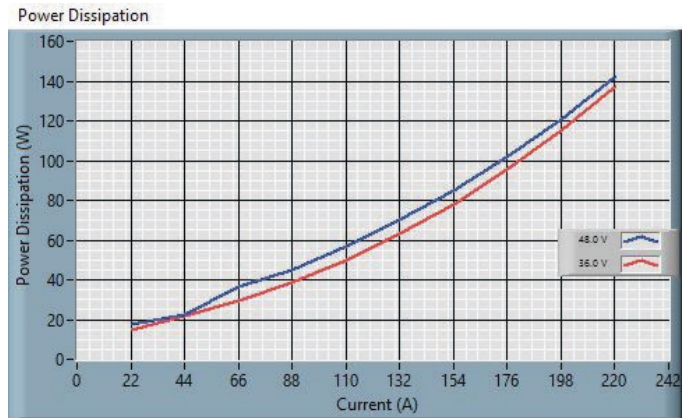

Fig. 2: 48S12.3K0BCA Power Dissipation – Buck Mode, $V_o=14V$.

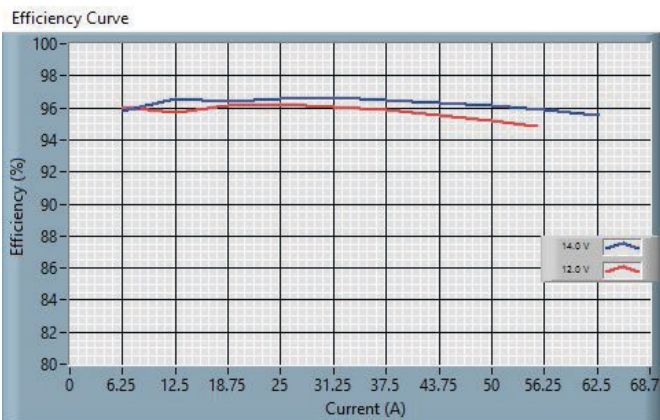

Fig. 3: 48S12.3K0BCA Efficiency Curve – Boost Mode, $V_o=48V$

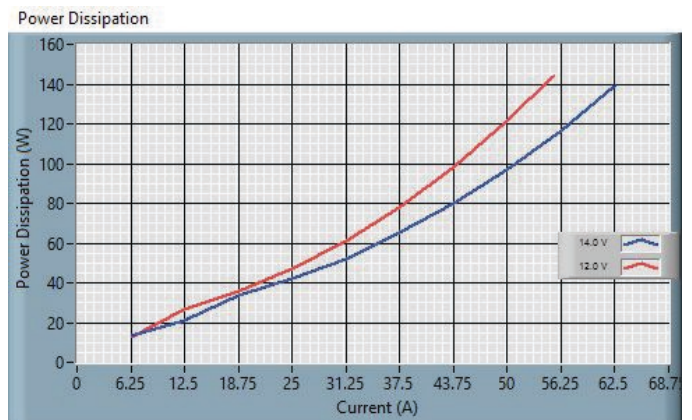

Fig. 4: 48S12.3K0BCA Power Dissipation – Boost Mode $V_o=48V$



BCA Series, 3000 Watt

12V Bi-Directional DC/DC Converter

Mechanical Specification

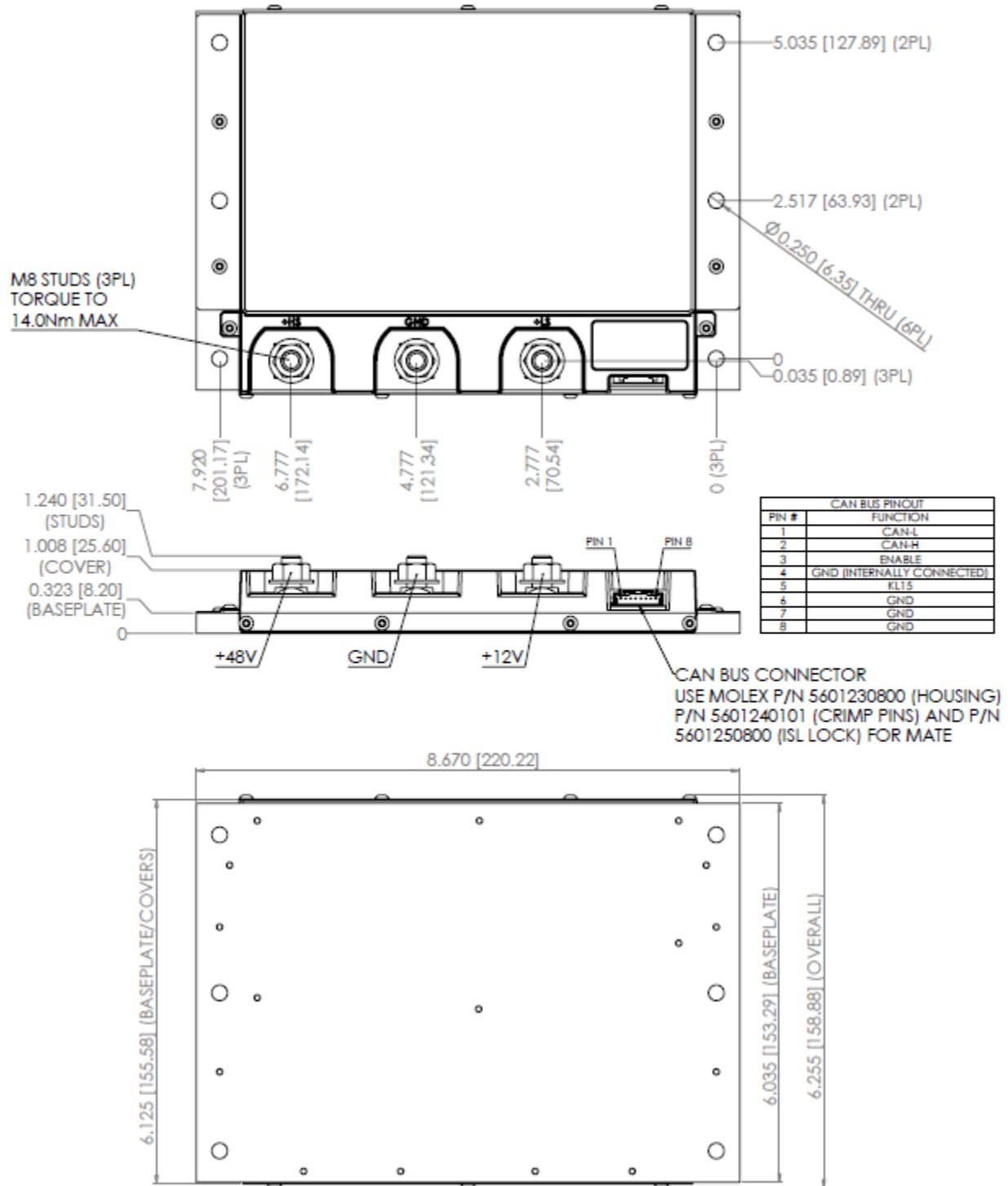

NOTES:

Unless otherwise specified:
All dimensions are in inches
Tolerances: x.xx in. ±0.02 in.