

MXW Series 500 Watt

DC/DC Converters



Product Overview

The 4:1 Input Voltage 500-Watt Single MXW DC/DC converter provides a precisely regulated dc output. The output voltage is fully isolated from the input, allowing the output to be positive or negative polarity and with various ground connections. The 500 Watt MXW meets the most rigorous performance standards in an industry standard footprint for mobile (12VIN), process control (24VIN), and military COTS (28VIN) applications.

The 4:1 Input Voltage 500 Watt MXW includes trim and remote ON/OFF. Threaded through holes are provided to allow easy mounting or addition of a heatsink for extended temperature operation. (Non-threaded option is available, see ordering information under model selection table.)

The converters high efficiency and high-power density are accomplished through use of high-efficiency synchronous rectification technology, advanced electronic circuit, packaging and thermal design thus resulting in a high reliability product. Converter operates at a fixed frequency and follows conservative component de-rating guidelines.

Features

- 4:1 Input voltage range
- High power density
- Small size 2.4" x 2.5" x 0.52"
- Efficiency up to 95.7%
- Excellent thermal performance
- Metal Baseplate
- Over-Current and Short Circuit Protection
- Over-Temperature protection
- Auto-restart
- Monotonic startup into pre-bias
- Constant frequency
- Remote ON/OFF
- Good shock and vibration damping
- Temperature Range -40°C to +105°C Available
- RoHS Compliant
- UL60950 Approved
- 5 Year Warranty

Contents

| | |
|---|---|
| Part Number Selection Table & Description | 2 |
| Electrical Specifications | 3 |
| Environmental and Mechanical Specifications | 7 |
| Operations | 8 |

| | |
|--------------------------------|----|
| Protection Features | 9 |
| Characteristic Curves | 12 |
| Characteristic Waveforms | 14 |
| EMC Consideration | 17 |
| Mechanical Specification | 18 |



MXW Series 500 Watt

DC/DC Converters

Part Number Selection Table

| Voltage (Vdc) | | Current | | | | Efficiency | Ripple & Noise | Regulation | Capacitive Load | Root Model |
|---------------|-----------|----------|--------------|--------------|------------|-------------------------|-----------------|---------------------|----------------------|----------------------------|
| Input | Output | Input | Output | | | | | | | |
| Vin Nom | Vin Range | Vout Nom | No Load (mA) | Max Load (A) | Io Max (A) | Typical at Max Load (%) | Typical (mVp-p) | Line / Load Max (%) | Max. C external (µF) | Basic Model without option |
| 24 | 9 – 36 | 12 | .24 | 50 | 41 | 94 | 120 | .05/.08 | 4700 | 24S12.41MXW |
| | | 24 | .24 | 50 | 21 | 94.3 | 240 | .05/.08 | 2200 | 24S24.21MXW |
| | | 28 | .24 | 50 | 18 | 95 | 280 | .05/.08 | 2200 | 24S28.18MXW |

1. Negative Logic On/Off feature is available. Add “-N” to the part number when ordering. i.e. 24S12.41MXW-N (ROHS)
2. Available with non-threaded mounting inserts. Add -I to the part number when ordering. i.e. 24S28.18MXW-I (ROHS)
3. Designed to meet MIL-STD-810G for functional shock and vibration. The unit must be properly secured to the interface medium (PCB/Chassis) by use of the threaded inserts of the unit.
4. A thermal management device, such as a heatsink, is required to ensure proper operation of this device. The thermal management medium is required to maintain baseplate < 105°C for full rated power.
5. Non-standard output voltages are available. Please contact the factory for additional information.

Part Number Description

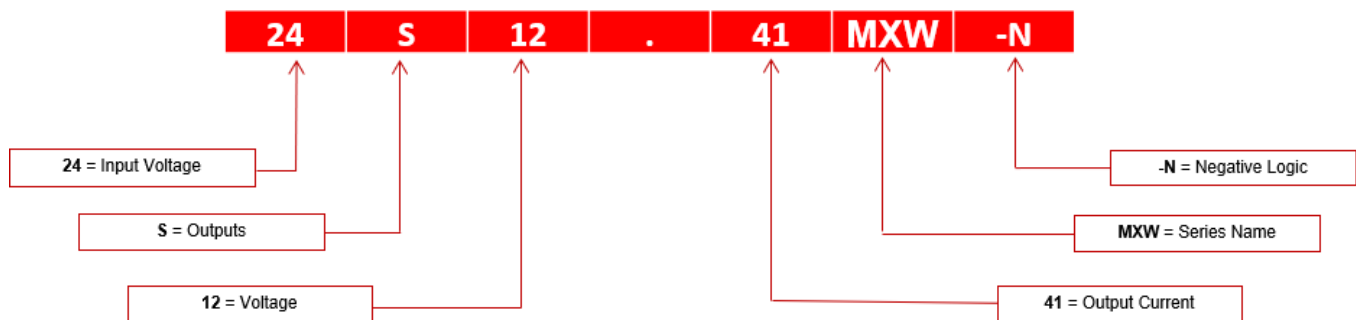



MXW Series 500 Watt

DC/DC Converters

Electrical Specifications

Conditions: $T_A = 25^\circ\text{C}$, airflow = 300 LFM (1.5m/s), $V_{IN} = 24\text{Vdc}$, unless otherwise specified. Specifications subject to change without notice.

| All Models | | | | | |
|---|---|------|-------|----------|---------------------------|
| Parameter | Notes | Min | Typ | Max | Units |
| Absolute Maximum Ratings | | | | | |
| Input Voltage | Continuous | 0 | | 40 | V |
| | Transient (100ms) | | | 50 | V |
| Operating Temperature | Baseplate (100% load) | -40 | | 105 | $^\circ\text{C}$ |
| Storage Temperature | | -55 | | 125 | $^\circ\text{C}$ |
| Isolation Characteristics and Safety | | | | | |
| Isolation Voltage | Input to Output | 2250 | | | V |
| | Input to Baseplate & Output to Baseplate | 1500 | | | V |
| Isolation Capacitance | | | 4500 | | pF |
| Isolation Resistance | | 10 | 20 | | $\text{M}\Omega$ |
| Insulation Safety Rating | | | Basic | | |
| Designed to meet UL/cUL 60950, IEC/EN 60950-1 | | | | | |
| Feature Characteristics | | | | | |
| Fixed Switching Frequency | Output Voltage Ripple has twice this frequency | | 200 | | kHz |
| Output Voltage Trim Range | | | | ± 10 | % |
| Remote Sense Compensation | This function is not provided | | N/A | | % |
| Output Overvoltage Protection | Non-latching | 117 | 124 | 130 | % |
| Over Temperature Shutdown (Baseplate) | Non-latching | | 110 | 120 | $^\circ\text{C}$ |
| Auto-Restart Period | Applies to all protection features | 450 | 500 | 550 | ms |
| Turn-On Time from VIN | Time from UVLO to $V_o=90\%$ V_{out} (NOM) Resistive load | | 517 | 530 | ms |
| Turn-On time from ON/OFF Control | Trim from ON to $V_o=90\%$ V_{out} (NOM) Resistive load | | 17 | 20 | ms |
| Rise Time | V_{out} from 10% to 90% | 4 | 7.5 | 11 | ms |
| ON/OFF Control – Positive Logic | | | | | |
| On State | Pin open = ON or external voltage applied | 2 | | 12 | V |
| Current Control | Leakage current | | | 0.16 | mA |
| OFF State | | 0 | | 0.8 | V |
| Control Current | Sinking | 0.3 | | 0.36 | mA |
| ON/OFF Control – Negative Logic | | | | | |
| ON State | Pin shorted to -INPUT or | | | 0.8 | V |
| OFF State | Pin open = OFF or | 2 | | 12 | V |
| Thermal Characteristics | | | | | |
| Thermal resistance Baseplate to Ambient | Converter soldered to 3.95" x 2.5" x 0.07" 4 layer / 2oz copper FR4 PCB | | 5.2 | | $^\circ\text{C}/\text{W}$ |



MXW Series 500 Watt

DC/DC Converters

Electrical Specifications (Continued):

Conditions: $T_A = 25^\circ\text{C}$, airflow = 300 LFM (1.5m/s), $V_{IN} = 24\text{Vdc}$, unless otherwise specified. Specifications subject to change without notice.

| 24S12.41MXW | | | | | | |
|---|---|------------------|-----------|-----------|----------------------------|--|
| Parameter | Notes | Min | Typ | Max | Units | |
| Input Characteristics | | | | | | |
| Operating Input Voltage Range | | 9 | 24 | 36 | V | |
| Input Under Voltage Lockout | Non-latching | | | | | |
| Turn-on Threshold | | 8.2 | 8.5 | 8.8 | V | |
| Turn-off Threshold | | 7.7 | 8 | 8.3 | V | |
| Lockout Hysteresis Voltage | | 0.4 | 0.55 | 0.7 | V | |
| Maximum Input Current | $V_{IN} = 9\text{V}$, 80% Load | | | 50.4 | A | |
| | $V_{IN} = 12\text{V}$, 100% Load | | | 46.2 | A | |
| | $V_{IN} = 24\text{V}$, Output Shorted | | 65 | | mA_{RMS} | |
| Input Stand-by Current | Converter Disabled | | 2 | 4 | mA | |
| Input Current @ No Load | Converter Enabled | | 240 | 280 | mA | |
| Minimum Input Capacitance (external) | ESR < 0.1 Ω | 470 | | | μF | |
| Inrush Transient | $V_{in} = 36\text{V}$ (0.4V/ μs) no input external capacitor | | 0.4 | 1 | A^2s | |
| Input Terminal Ripple Current, i_c | 25 MHz bandwidth, 100% Load (Fig. 2) | | 620 | | mA_{RMS} | |
| Output Characteristics | | | | | | |
| Output Voltage Range | | 11.64 | 12.00 | 12.36 | V | |
| Output Voltage Set Point Accuracy | (50% Load) | 11.88 | 12.00 | 12.12 | V | |
| Output Regulation | | | | | | |
| Over Line | $V_{IN} = 9\text{V}$ to 36V | | 0.05 | 0.15 | % | |
| Over Load | $V_{IN} = 24\text{V}$, Load 0% to 100% | | 0.08 | 0.15 | % | |
| Temperature Coefficient | | | 0.015 | 0.03 | $\text{\%/}^\circ\text{C}$ | |
| Over Voltage Protection | | 14.0 | | 15.6 | V | |
| Output Ripple and Noise – 20 MHz bandwidth | (Fig. 3) 100% Load | | 120 | 180 | $\text{mV}_{\text{PK-PK}}$ | |
| | $C_{\text{EXT}} = 470 \mu\text{F}/70\text{m}\Omega + 1 \mu\text{F}$ ceramic | | 30 | 60 | mV_{RMS} | |
| External Load Capacitance | Full Load (resistive) -40 $^\circ\text{C} < T_a < +105 \text{ }^\circ\text{C}$ | C_{EXT} | 470 | 4700 | μF | |
| | | ESR | 10 | 100 | $\text{m}\Omega$ | |
| Output Current Range (See Fig. A) | $V_{IN} = 12\text{V}$ to 36V | 0 | | 41 | A | |
| | $V_{IN} = 9\text{V}$ | 0 | | 33.3 | A | |
| Current Limit Inception | $V_{IN} = 12\text{V} - 36\text{V}$ | 45.1 | 49.2 | 53.3 | A | |
| | $9\text{V} < V_{IN} < 12\text{V}$ | 40.6 | | 53.3 | A | |
| RMS Short-Circuit Current | Non-latching, Continuous | | 4 | 7 | A_{RMS} | |
| Dynamic Response | | | | | | |
| Load change 50% - 75%, $di/dt = 1\text{A}/\mu\text{s}$ | $C_0 = 470 \mu\text{F}/70\text{m}\Omega + 1 \mu\text{F}$ ceramic | | ± 320 | ± 450 | mV | |
| Load change 50% - 100%, $di/dt = 1\text{A}/\mu\text{s}$ | $C_0 = 470 \mu\text{F}/70\text{m}\Omega + 1 \mu\text{F}$ ceramic | | ± 700 | | mV | |
| Setting Time to 1% of V_{out} | | | 600 | | μs | |
| Efficiency | | | | | | |
| 100% Load | $V_{IN} = 24\text{V}$ | 93.2 | 93.9 | 94.6 | % | |
| | $V_{IN} = 12\text{V}$ | 91.4 | 92.1 | 92.8 | % | |
| 50% Load | $V_{IN} = 24\text{V}$ | 94.7 | 95.4 | 96.1 | % | |
| | $V_{IN} = 12\text{V}$ | 93.9 | 94.6 | 95.2 | % | |



MXW Series 500 Watt

DC/DC Converters

Electrical Specifications (continued)

Conditions: $T_A = 25^\circ\text{C}$, airflow = 300 LFM (1.5m/s), $V_{IN} = 24\text{Vdc}$, unless otherwise specified. Specifications subject to change without notice.

| 24S24.21MXW | | | | | |
|---|---|------------------|-----------|-----------|----------------------------|
| Parameter | Notes | Min | Typ | Max | Units |
| Input Characteristics | | | | | |
| Operating Input Voltage Range | | 9 | 24 | 36 | V |
| Input Under Voltage Lockout | Non-latching | | | | |
| Turn-on Threshold | | 8.2 | 8.5 | 8.8 | V |
| Turn-off Threshold | | 7.7 | 8 | 8.3 | V |
| Lockout Hysteresis Voltage | | 0.4 | 0.55 | 0.7 | V |
| Maximum Input Current | $V_{IN} = 9\text{V}$, 80% Load | | | 50.4 | A |
| | $V_{IN} = 12\text{V}$, 100% Load | | | 47.0 | A |
| | $V_{IN} = 24\text{V}$, Output Shorted | | 75 | | mA_{RMS} |
| Input Stand-by Current | Converter Disabled | | 2 | 4 | mA |
| Input Current @ No Load | Converter Enabled | | 240 | 300 | mA |
| Minimum Input Capacitance (external) | ESR < 0.1 Ω | 470 | | | μF |
| Inrush Transient | $V_{in} = 36\text{V}$ (0.4V/ μs) no input external capacitor | | 0.4 | 1 | A^2s |
| Input Terminal Ripple Current, i_C | 25 MHz bandwidth, 100% Load (Fig. 2) | | 680 | | mA_{RMS} |
| Output Characteristics | | | | | |
| Output Voltage Range | | 23.28 | 24.00 | 24.72 | V |
| Output Voltage Set Point Accuracy | (50% Load) | 23.76 | 24.00 | 24.24 | V |
| Output Regulation | | | | | |
| Over Line | $V_{IN} = 9\text{V}$ to 36V | | 0.05 | 0.15 | % |
| Over Load | $V_{IN} = 24\text{V}$, Load 0% to 100% | | 0.08 | 0.15 | % |
| Temperature Coefficient | | | 0.015 | 0.03 | $\%/^\circ\text{C}$ |
| Over Voltage Protection | | 28.1 | | 31.2 | V |
| Output Ripple and Noise – 20 MHz bandwidth | (Fig. 3) 100% Load | | 240 | 360 | $\text{mV}_{\text{PK-PK}}$ |
| | $C_{\text{EXT}} = 470 \mu\text{F}/70\text{m}\Omega + 1 \mu\text{F}$ ceramic | | 50 | 80 | mV_{RMS} |
| External Load Capacitance | Full Load (resistive) $-40^\circ\text{C} < T_a < +105^\circ\text{C}$ | C_{EXT} | 470 | 2200 | μF |
| | | ESR | 10 | 100 | $\text{m}\Omega$ |
| Output Current Range (See Fig. A) | $V_{IN} = 12\text{V}$ to 36V | 0 | | 21 | A |
| | $V_{IN} = 9\text{V}$ | 0 | | 16.7 | A |
| Current Limit Inception | $V_{IN} = 12\text{V} - 36\text{V}$ | 23.1 | 25.2 | 27.3 | A |
| | $9\text{V} < V_{IN} < 12\text{V}$ | 20.8 | | 27.3 | A |
| RMS Short-Circuit Current | Non-latching, Continuous | | 3.8 | 6 | A_{RMS} |
| Dynamic Response | | | | | |
| Load change 50% - 75%, $di/dt = 1\text{A}/\mu\text{s}$ | $C_0 = 470 \mu\text{F}/70\text{m}\Omega + 1 \mu\text{F}$ ceramic | | ± 280 | ± 420 | mV |
| Load change 50% - 100%, $di/dt = 1\text{A}/\mu\text{s}$ | $C_0 = 470 \mu\text{F}/70\text{m}\Omega + 1 \mu\text{F}$ ceramic | | ± 500 | | mV |
| Setting Time to 1% of V_{out} | | | 600 | | μs |
| Efficiency | | | | | |
| 100% Load | $V_{IN} = 24\text{V}$ | 93.6 | 94.3 | 95 | % |
| | $V_{IN} = 12\text{V}$ | 92.3 | 93.0 | 93.7 | % |
| 50% Load | $V_{IN} = 24\text{V}$ | 94.5 | 95.4 | 96.3 | % |
| | $V_{IN} = 12\text{V}$ | 94.5 | 95.2 | 95.9 | % |



MXW Series 500 Watt

DC/DC Converters

Electrical Specifications (continued)

Conditions: $T_A = 25^\circ\text{C}$, airflow = 300 LFM (1.5m/s), $V_{IN} = 24\text{Vdc}$, unless otherwise specified. Specifications subject to change without notice.

| 24S28.18MXW | | | | | |
|---|---|------------------|-----------|-----------|----------------------------|
| Parameter | Notes | Min | Typ | Max | Units |
| Input Characteristics | | | | | |
| Operating Input Voltage Range | | 9 | 24 | 36 | V |
| Input Under Voltage Lockout | Non-latching | | | | |
| Turn-on Threshold | | 8.2 | 8.5 | 8.8 | V |
| Turn-off Threshold | | 7.7 | 8 | 8.3 | V |
| Lockout Hysteresis Voltage | | 0.4 | 0.55 | 0.7 | V |
| Maximum Input Current | $V_{IN} = 9\text{V}$, 80% Load | | | 50.4 | A |
| | $V_{IN} = 12\text{V}$, 100% Load | | | 46.2 | A |
| | $V_{IN} = 24\text{V}$, Output Shorted | | 55 | | mA_{RMS} |
| Input Stand-by Current | Converter Disabled | | 2 | 4 | mA |
| Input Current @ No Load | Converter Enabled | | 240 | 280 | mA |
| Minimum Input Capacitance (external) | ESR < 0.1 Ω | 470 | | | μF |
| Inrush Transient | $V_{in} = 36\text{V}$ (0.4V/ μs) no input external capacitor | | 0.4 | 1 | A^2s |
| Input Terminal Ripple Current, i_C | 25 MHz bandwidth, 100% Load (Fig. 2) | | 550 | | mA_{RMS} |
| Output Characteristics | | | | | |
| Output Voltage Range | | 27.16 | 28.00 | 28.84 | V |
| Output Voltage Set Point Accuracy | (50% Load) | 27.72 | 28.00 | 28.28 | V |
| Output Regulation | | | | | |
| Over Line | $V_{IN} = 9\text{V}$ to 36V | | 0.05 | 0.15 | % |
| Over Load | $V_{IN} = 24\text{V}$, Load 0% to 100% | | 0.08 | 0.15 | % |
| Temperature Coefficient | | | 0.015 | 0.03 | $\%/^\circ\text{C}$ |
| Over Voltage Protection | | 32.8 | | 36.4 | V |
| Output Ripple and Noise – 20 MHz bandwidth | (Fig. 3) 100% Load | | 280 | 380 | $\text{mV}_{\text{PK-PK}}$ |
| | $C_{\text{EXT}} = 470 \mu\text{F}/70\text{m}\Omega + 1 \mu\text{F}$ ceramic | | 50 | 85 | mV_{RMS} |
| External Load Capacitance | Full Load (resistive) $-40^\circ\text{C} < T_A < +105^\circ\text{C}$ | C_{EXT} | 470 | 2200 | μF |
| | | ESR | 10 | 100 | $\text{m}\Omega$ |
| Output Current Range (See Fig. A) | $V_{IN} = 12\text{V}$ to 36V | 0 | | 18 | A |
| | $V_{IN} = 9\text{V}$ | 0 | | 14.3 | A |
| Current Limit Inception | $V_{IN} = 12\text{V} - 36\text{V}$ | 19.8 | | 23.4 | A |
| | $9\text{V} < V_{IN} < 12\text{V}$ | 17.8 | | 23.4 | A |
| RMS Short-Circuit Current | Non-latching, Continuous | | 2.2 | 6 | A_{RMS} |
| Dynamic Response | | | | | |
| Load change 50% - 75%, $di/dt = 1\text{A}/\mu\text{s}$ | $C_0 = 470 \mu\text{F}/70\text{m}\Omega + 1 \mu\text{F}$ ceramic | | ± 270 | ± 410 | mV |
| Load change 50% - 100%, $di/dt = 1\text{A}/\mu\text{s}$ | $C_0 = 470 \mu\text{F}/70\text{m}\Omega + 1 \mu\text{F}$ ceramic | | ± 500 | | mV |
| Setting Time to 1% of V_{out} | | | 800 | | μs |
| Efficiency | | | | | |
| 100% Load | $V_{IN} = 24\text{V}$ | 94.3 | 95.0 | 95.7 | % |
| | $V_{IN} = 12\text{V}$ | 93.1 | 93.8 | 94.5 | % |
| 50% Load | $V_{IN} = 24\text{V}$ | 95.0 | 95.7 | 96.4 | % |
| | $V_{IN} = 12\text{V}$ | 94.1 | 94.8 | 95.5 | % |

Environmental and Mechanical Specifications

Specifications subject to change without notice.

| Parameter | Note | Min | Typ | Max | Units |
|--------------------------------------|--|--------------------------------|-------|-------|--------|
| Environmental | | | | | |
| Operating Humidity | Non-condensing | | | 95 | % |
| Storage Humidity | Non-condensing | | | 95 | % |
| ROHS Compliance ¹ | See Calex Website http://www.calex.com/RoHS.html for the complete RoHS Compliance Statement | | | | |
| Shock and Vibration | Designed to meet MIL-STD-810G for functional shock and vibration | | | | |
| Water Washability | Not recommended for water wash process. Contact the factory for more information. | | | | |
| Mechanical | | | | | |
| Weight | | | 3.85 | | Ounces |
| | | | 109.2 | | Grams |
| PCB | | | | | |
| Operating Temperature | | | | 130 | °C |
| Tg | | 170 | | | °C |
| Through Hole Pin Diameters | Pins 1 ,4, 5 and 9 | 0.079 | 0.081 | 0.083 | Inches |
| | | 2.006 | 2.057 | 2.108 | mm |
| | Pins 3 and 7 | 0.038 | 0.04 | 0.042 | Inches |
| | | 0.965 | 1.016 | 1.067 | mm |
| Through Hole Pin Material | Pins 1, 4, 5 and 9 | C14500 or C1100 Copper Alloy | | | |
| | Pins 3 and 7 | Brass Alloy TB3 or "Eco Brass" | | | |
| Through Hole Pin Finish | All pins | 10μ" Gold over Nickel | | | |
| Case Dimensions | | 2.4 x 2.5 x 0.52 | | | Inches |
| | | 60.96 x 63.50 x 13.21 | | | mm |
| Case Material | Plastic: Vectra LCP FIT30: ½ - 16 EDM Finish | | | | |
| Baseplate | Material | Aluminum | | | |
| | Flatness | | 0.008 | | Inches |
| | | | | 0.20 | |
| Reliability | | | | | |
| MTBF | Telcordia SR-332, Method 1 Case 1 50% electrical stress, 40 °C components | | 5.4 | | MHrs |
| Agency Approvals | UL60950 Approved | | | | |
| EMI and Regulatory Compliance | | | | | |
| Conducted Emissions | MIL-STD-461F CE102 with external EMI filter network (see Figs, 28 and 29) | | | | |

Additional Notes:

1 The RoHS marking is as follows

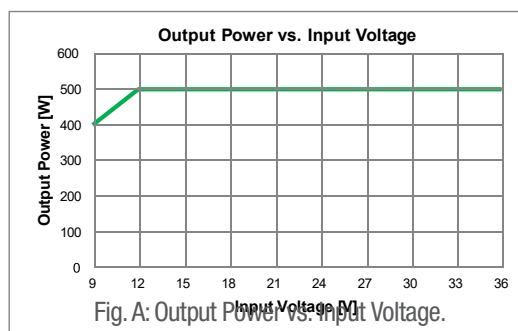

Fig. A: Output Power vs. Input Voltage.

Operations

Input and Output Capacitance

In many applications, the inductance associated with the distribution from the power source to the input of the converter can affect the stability of the converter. This becomes of great consideration for input voltage at 12V or below.

To enable proper operation of the converter, in particular during load transients, an additional input capacitor is required. Minimum required input capacitance, mounted close to the input pins, is 470 μ F with ESR < 0.1 Ω . Since inductance of the input power cables could have significant voltage drop due to rate of change of input current $di(in)/dt$ during transient load operation an external capacitance on the output of the converter is required to reduce $di(in)/dt$. It is required to use at least 470 μ F (ESR < 0.07 Ω) on the output. Another constraint is minimum rms current rating of the input and output capacitors which is application dependent.

One component of input rms current handled by input capacitor is high frequency component at switching frequency of the converter (typ. 400kHz) and is specified under “Input terminal ripple current” *ic*. Typical values at full rated load and 24 Vin are provided in Section “Characteristic Waveforms” for each model and are in range of 0.55A - 0.7A. A second component of the ripple current is due to reflected step load current on the input of the converter. Similar consideration needs to be taken into account for output capacitor and in particular step load ripple current component. Consult the factory for further application guidelines.

Additionally, for EMI conducted measurement it is necessary to use 5 μ H LISNs instead of typical 50 μ H LISNs.

ON/OFF (Pin 3)

The ON/OFF pin is used to turn the power converter on or off remotely via a system signal and has positive logic. A typical connection for remote ON/OFF function is shown in Figure 1.

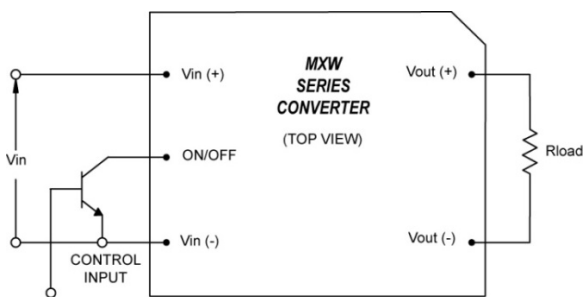

The positive logic version turns on when the ON/OFF pin is at logic high and turns off when at logic low. The converter is on when the ON/OFF pin is either left open or external voltage not more than 12V is applied between ON/OFF pin and -INPUT pin. See the Electrical Specifications for logic high/low definitions.

The negative logic version turns on when the ON/OFF pin is at logic low and turns off when at logic high. The converter is on when the ON/OFF pin is either shorted to -INPUT pin or kept below 0.8V. The converter is off when the ON/OFF pin is either left open or external voltage greater than 2V and not more than 12V is applied between ON/OFF pin and -INPUT pin. See the Electrical Specifications for logic high/ low definitions.

The ON/OFF pin is internally pulled up to typically 4.5V via resistor and connected to internal logic circuit via RC circuit in order to filter out noise that may occur on the ON/ OFF pin. A properly de-bounced mechanical switch, open- collector transistor, or FET can be used to drive the input of the ON/OFF pin. The device must be capable of sinking up to 0.36mA at a low level voltage of \leq 0.8V. During logic high, the typical maximum voltage at ON/OFF pin (generated by the converter) is 4.5V, and the maximum allowable leakage current is 160 μ A. If not using the remote on/off feature leave the ON/OFF pin open.

TTL Logic Level - The range between 0.81V as maximum turn off voltage and 2V as minimum turn on voltage is considered the dead-band. Operation in the dead-band is not recommended.

External voltage for ON/OFF control should not be applied when there is no input power voltage applied to the converter.



Protection Features

Input Undervoltage lockout (UVLO)

Input undervoltage lockout is standard with this converter. The converter will shut down when the input voltage drops below a pre-determined voltage.

The input voltage must be typically above 8.5V for the converter to turn on. Once the converter has been turned on, it will shut off when the input voltage drops typically below 8V. If the converter is started by input voltage (ON/ OFF (pin 3) left open) there is typically 500msec delay from the moment when input voltage is above 8.5V turn-on voltage and the time when output voltage starts rising. This delay is intentionally provided to prevent potential startup issues especially at low input voltages.

Output Overcurrent Protection (OCP)

The converter is protected against overcurrent or short circuit conditions. Upon sensing an overcurrent condition, the converter will switch to constant current operation and thereby begin to reduce output voltage. When the output voltage drops below approx. 75% of the nominal value of output voltage, the converter will shut down. Once the converter has shut down, it will attempt to restart nominally every 500msec with a typical 3% duty cycle.

The attempted restart will continue indefinitely until the overload or short circuit conditions are removed or the output voltage rises above 75% of its nominal value.

Once the output current is brought back into its specified range, the converter automatically exits the hiccup mode and continues normal operation.

During initial startup, if output voltage does not exceed typical 75% of nominal output voltage within 20 msec after the converter is enabled, the converter will be shut down and will attempt to restart after 500 msec.

Output Overvoltage Protection (OVP)

The converter will shut down if the output voltage across Vout (+) (Pin 5) and Vout (-) (Pin 9) exceeds the threshold of the OVP circuitry. The OVP circuitry contains its own reference, independent of the output voltage regulation loop. Once the converter has shut down, it will attempt to restart every 500 msec until the OVP condition is removed.

Over Temperature Protection (OTP)

The MXW converters have non-latching over temperature protection. It will shut down and disable the output if temperature at the center of the base plate exceeds a threshold of 112°C (typical).

The converter will automatically restart when the base temperature has decreased by approximately 20°C.

Safety Requirements

Basic Insulation is provided between input and the output.

The converters have no internal fuse. To comply with safety agency requirements, a fast-acting or time-delay fuse is to be provided in the unearthed lead.

Recommended fuse values are:

- a) 60A for $9V < V_{IN} < 18V$
- b) 30A for $18V < V_{IN} < 36V$

Electromagnetic Compatibility (EMC)

EMC requirements must be met at the end-product system level, as no specific standards dedicated to EMC characteristics of board mounted component DC-DC converters exist.

With the addition of a single stage external filter, the MXW converters will pass the requirements of MIL-STD-461F CE102 Base Curve for conducted emissions.

Absence of the Remote Sense Pins

Customers should be aware that MXW converters do not have a Remote Sense feature. Care should be taken to minimize voltage drop on the user's motherboard as well as if trim function is used.

Output Voltage Adjust/TRIM (Pin 7)

The TRIM pin allows user to adjust output voltage 10% up or down relative to rated nominal voltage by addition of external trim resistor. Due to absence of Remote Sense Pins, an external trim resistor should be connected to output pins using Kelvin connection. If trimming is not used, the TRIM pin should be left open.

Trim Down – Decrease Output Voltage

Trimming down is accomplished by connecting an external resistor, $R_{TRIM-DOWN}$, between the TRIM (pin 7) and the Vout- (pin 9), using a Kelvin connection with a value of:

$$R_{TRIM-DOWN} = \left(\frac{3010}{\Delta} - 60.2 \right) = [k\Omega]$$

where,

$R_{trim-down}$ = Required value of the trim-down resistor [kΩ]

$V_{O(NOM)}$ = Nominal value of output voltage [V]

$V_{O(REQ)}$ = Required value of output voltage [V]

$$\Delta = \left| \frac{V_{O(req.)} - V_{O(nom.)}}{V_{O(nom.)}} \right| [%]$$

To trim the output voltage 10% ($\Delta=10$) down, required external trim resistance is:

$$R_{(Trim-Down)} = \left(\frac{3010}{10} - 60.2 \right) = 240.8k\Omega$$

Trim Up – Increase Output Voltage

Trimming up is accomplished by connecting an external resistor, $R_{TRIM-UP}$, between the TRIM (pin 7) and the VOUT(+) (pin 5), with a value of:

$$R_{(Trim-Up)} = 30.1 \times \left[\frac{V_{o(nom.)} \times (100 + \Delta)}{1.225 \times \Delta} - \frac{100 + 2\Delta}{\Delta} \right] [k\Omega]$$

To trim the output voltage up (for example 24V to 26.4V), $\Delta=10$ and required external resistor is:

$$R_{(Trim-Up)} = 30.1 \times \left[\frac{24 \times (100 + 10)}{1.225 \times 10} - \frac{100 + (2 \times 10)}{10} \right] = 6125 [k\Omega]$$

Note that trimming output voltage more than 10% is not recommended and OVP might be tripped.

Active Voltage Programming

In applications where output voltage needs to be adjusted actively, an external voltage source (for example a Digital-to-Analog converter), capable of both sourcing and sinking current can be used. It should be connected with series resistor R_g across TRIM (pin 7) and VOUT(-) (pin 9) using Kelvin connection. Contact a Calex technical representative for more details.

Thermal Consideration

The MXW converter can operate in a variety of thermal environments. However, to ensure reliable operation of the converter, sufficient cooling should be provided. The MXW converter is encapsulated in plastic case with metal baseplate on the top. To improve thermal performance, power components inside the unit are thermally coupled to the baseplate. In addition, thermal design of the converter is enhanced by use of input and output pins as heat transfer elements. Heat is removed from the converter by conduction, convection and radiation.

There are several factors such as ambient temperature, airflow, converter power dissipation, converter orientation of how the converter is mounted, and the need for increased reliability, which needs to be considered to achieve required performance. It is recommended to measure temperature in the middle of the baseplate in particular application to ensure that proper cooling of the convert is provided.

A reduction in the operating temperature of the converter results in increased reliability.

Thermal Derating

There are two most common applications: 1) the MXW converter is thermally attached to a cold plate inside chassis without any forced internal air circulation; 2) the MXW converter is mounted in an open chassis on system board with forced airflow with or without an additional heatsink attached to the baseplate of the MXW converter.

The best thermal results are achieved in application 1) since the converter is cooled entirely by conduction of heat from the top surface of the converter to a cold plate and temperature of the components is determined by the temperature of the cold plate. There is also additional heat removal through the converters pins to the metal layers in the system board. It is highly recommended to solder pins to the system board rather than using receptacles. Typical derating output power and current are shown in Figs. 10–15 for various baseplate temperatures up to 105°C. The converter was solder to the test card:

4.26" x 5.9" 4 layers FR4 PCB with 30z Cu inner layers and 2 Oz Cu outer layers, covered with solder mask. Note that operating converter at these limits for prolonged time affects reliability.

Soldering Guidelines

The ROHS-compliant through hole MXW converters use Sn/Ag/Cu Pb-free solder and ROHS compliant components. They are designed to be processed through wave soldering machines. The pins are 100% matte tin over nickel plated and compatible with both Pb and Pb-free wave soldering processes. It is recommended to follow the following specifications when installing and soldering MXW converters. Exceeding these specifications can cause damage to the MXW converter.

| Wave Solder Guideline for Sn/Ag/Cu based solders | |
|--|-----------|
| Maximum Preheat Temperature | 115 °C |
| Maximum Pot Temperature | 270 °C |
| Maximum Solder Dwell Time | 7 seconds |

| Wave Solder Guideline for SN/Pb based solders | |
|---|-----------|
| Maximum Preheat Temperature | 105 °C |
| Maximum Pot Temperature | 250 °C |
| Maximum Solder Dwell Time | 6 seconds |

MXW converters are not recommended for water wash process. Contact the factory for additional information if water wash is necessary.

Test Configurations

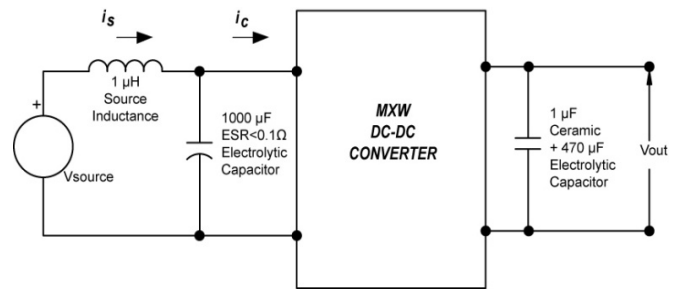

Figure 2: Test setup for measuring input reflected ripple currents i_c and i_s .

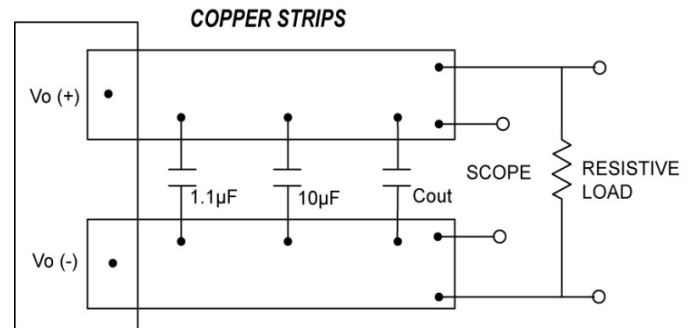

Figure 3: Test setup for measuring output voltage ripple, startup, and step load transient waveforms.

Characteristic Curves – Efficiency and Power Dissipation

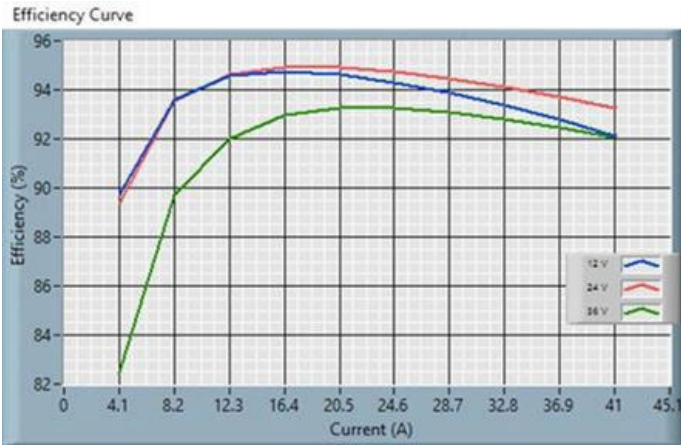

Fig. 4: 24S12.41MXW (ROHS) Efficiency Curve

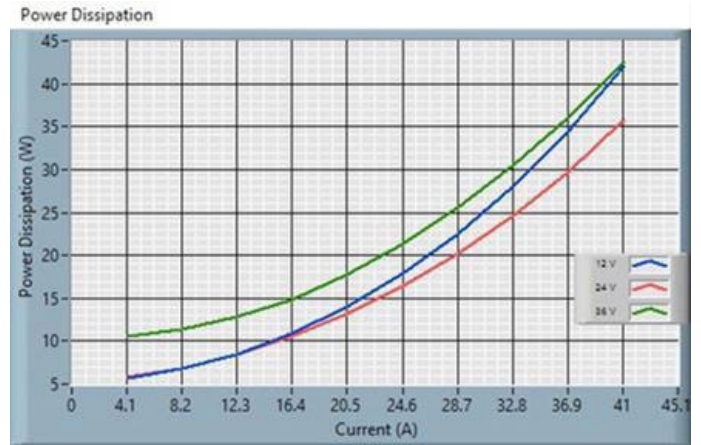

Fig. 5: 24S12.41MXW (ROHS) Power Dissipation

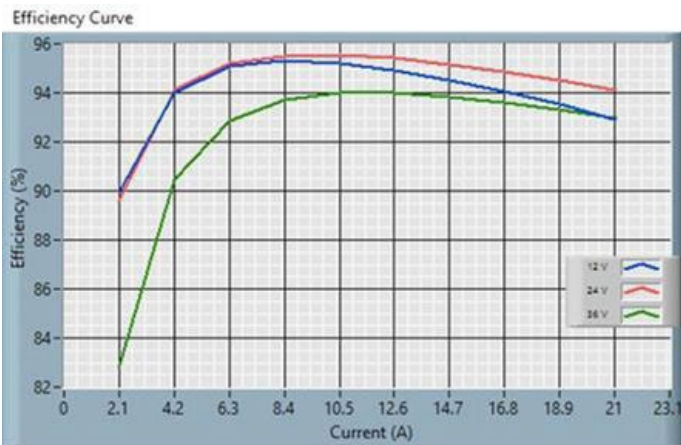

Fig. 6: 24S24.21MXW (ROHS) Efficiency Curve

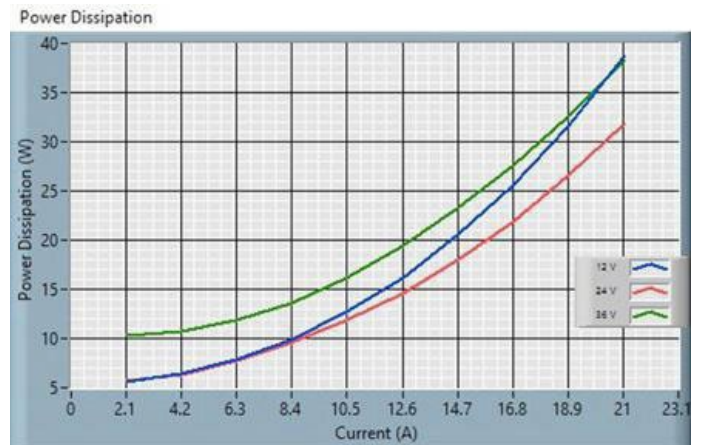

Fig. 7: 24S24.21MXW (ROHS) Power Dissipation

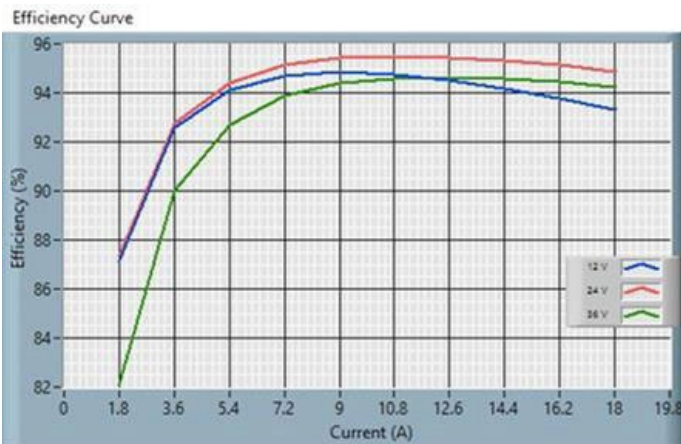

Fig. 8: 24S28.18MXW (ROHS) Efficiency Curve

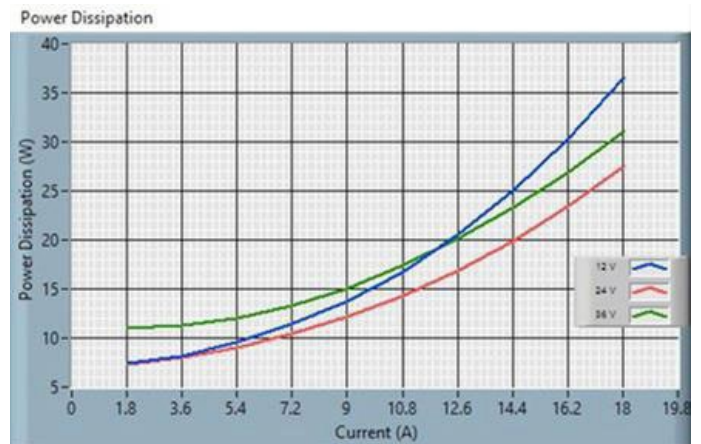
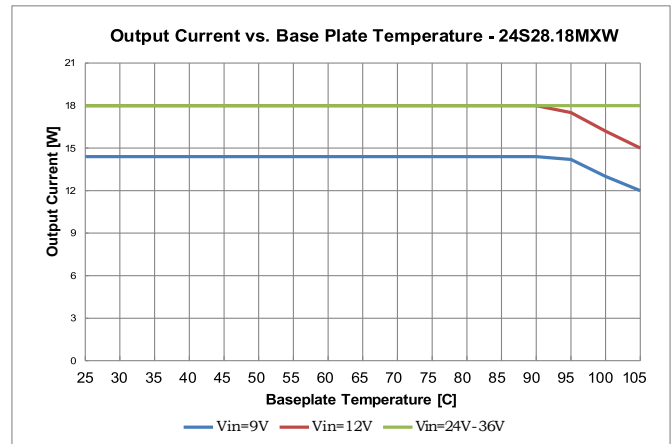
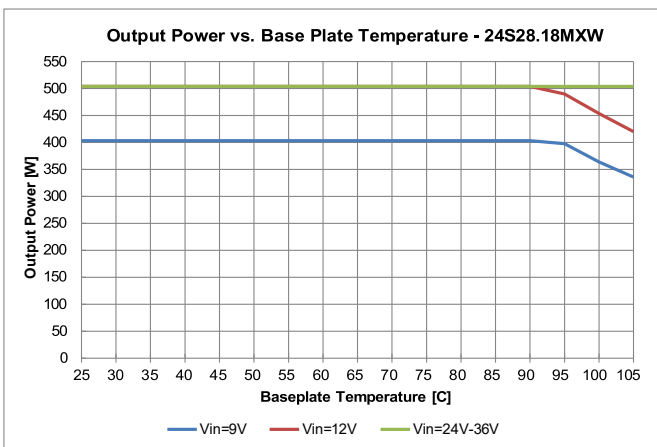
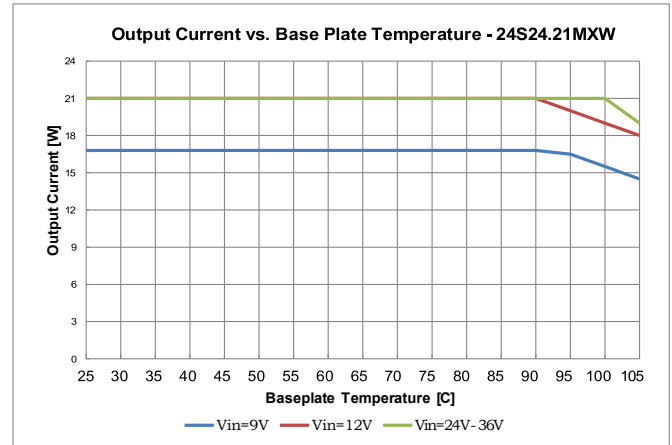
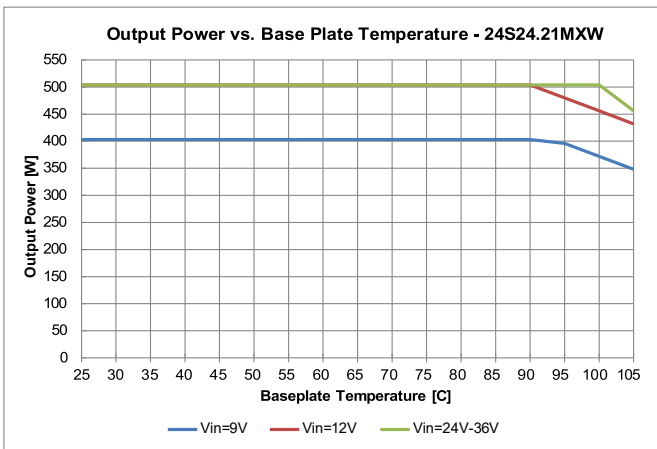
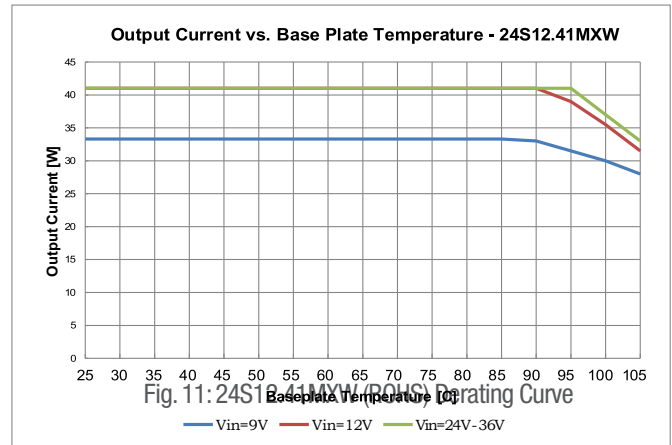
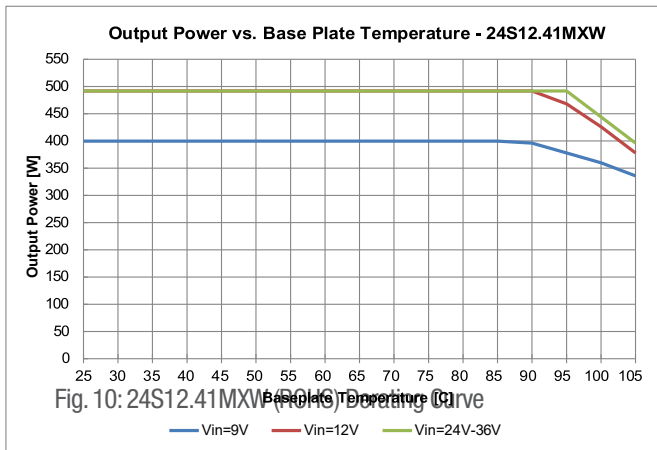

Fig. 9: 24S28.18MXW (ROHS) Power Dissipation

Characteristic Curves – Derating Curves



Characteristic Waveforms – 24S12.41MXW (ROHS)

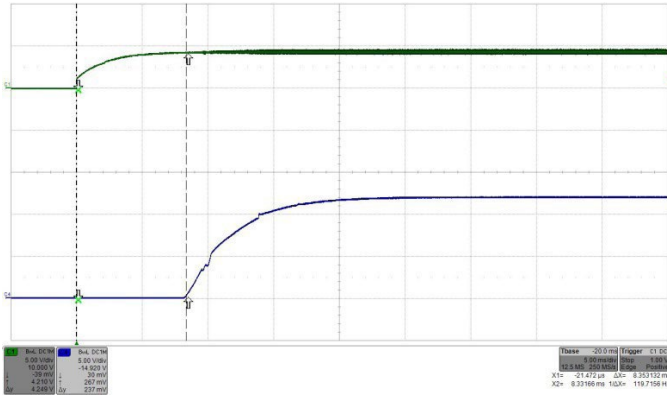

Fig. 16: Turn-on by ON/OFF transient (with VIN applied) at full rated load current (resistive) at VIN = 24V. Top trace (C1): ON/OFF signal (5V/div.). Bottom trace (C4): Output voltage (5 V/div.). Time 5 ms/div.

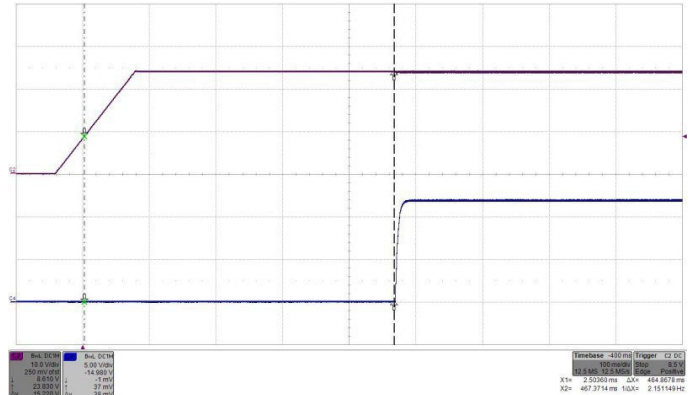

Fig. 17: Turn-on by VIN (ON/OFF high) transient at full rated load current (resistive) at VIN = 24V. Top trace (C2): Input voltage VIN (10 V/div.). Bottom trace (C4): Output voltage (5 V/div.). Time 100 ms/div.

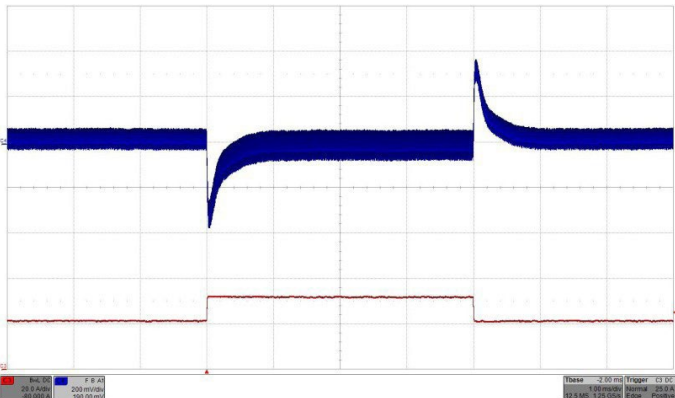

Fig. 18: Output voltage response to load current step change 50% - 75% - 50% (20.5A - 31.5A - 20.5A) with $di/dt = 1A/\mu s$ at VIN = 24V. Top trace (C4): Output voltage (200 mV/div.). Bottom trace (C3): Load current (20A/div.). C_0 470 μ F/70m Ω . Time: 1ms/div.

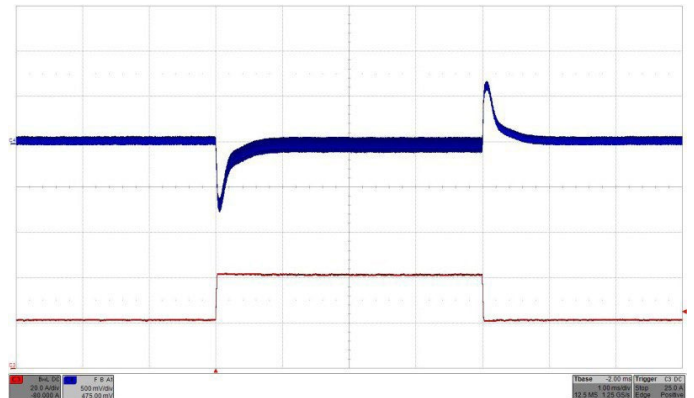

Fig. 19: Output voltage response to load current step change 50% - 100% - 50% (20.5A - 41A - 20.5A) with $di/dt = 1A/\mu s$ at VIN = 24V. Top trace (C4): Output voltage (500 mV/div.). Bottom trace (C3): Load current (20A/div.). C_0 470 μ F/70m Ω . Time: 1ms/div.

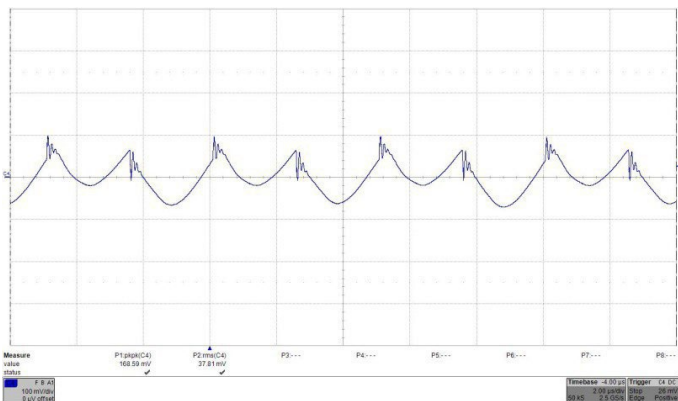

Fig. 20: Output voltage ripple (100mV/div.) at full rated load current into a resistive load at VIN = 24V. C_0 470 μ F/70m Ω . Time: 2 μ s/div.

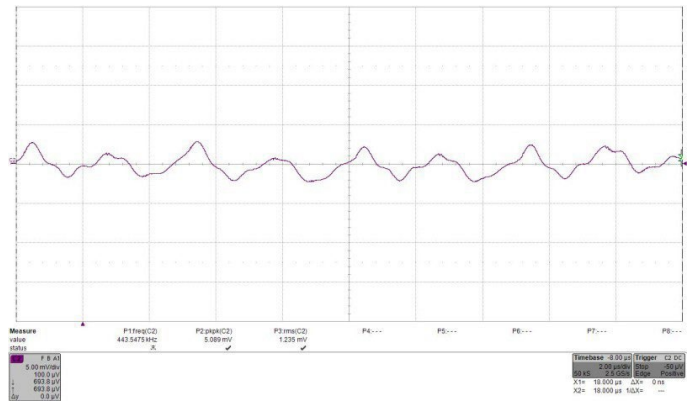

Fig. 21: Input reflected ripple current, i_c (500 mA/mV), measured at input terminals at full rated load current at VIN = 24V. Refer to Fig. 2 for test setup. Time: 2 μ s/div. RMS input ripple current is $1.235 \times 500mA = 617.5mA$.

Characteristic Waveforms – 24S24.21MXW (ROHS)

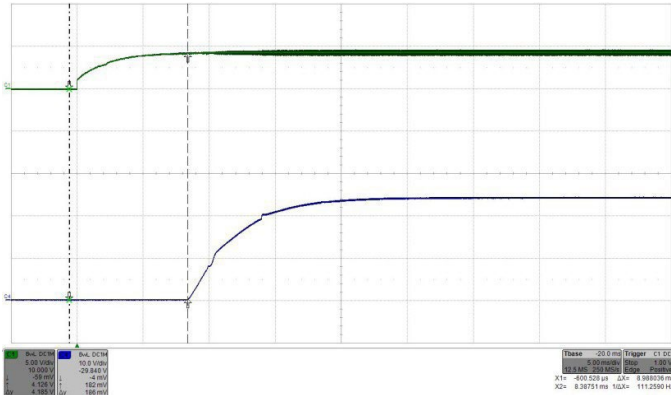

Fig. 22: Turn-on by ON/OFF transient (with VIN applied) at full rated load current (resistive) at VIN = 24V. Top trace (C1): ON/OFF signal (5V/div.). Bottom trace (C4): Output voltage (10 V/div.). Time 5 ms/div.

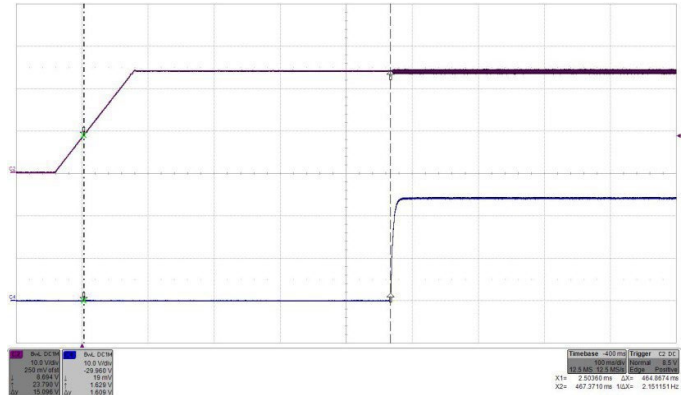

Fig. 23: Turn-on by VIN transient (ON/OFF high) at full rated load current (resistive) at VIN = 24V. Top trace (C2): Input voltage VIN (10 V/div.). Bottom trace (C4): Output voltage (10 V/div.). Time 100 ms/div.

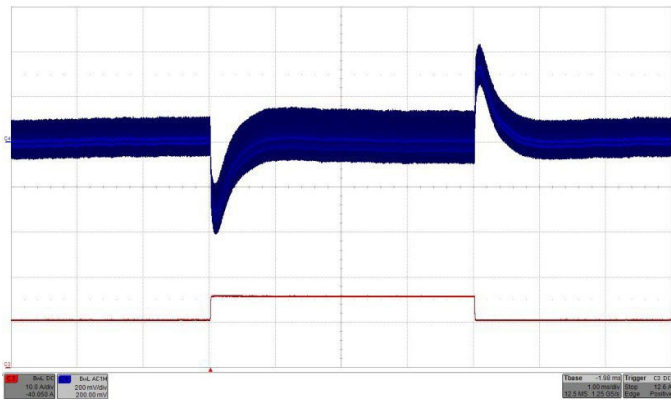

Fig. 24: Output voltage response to load current step change 50% - 75% - 50% (10.5A - 15.75A - 10.5A) with $di/dt = 1A/\mu s$ at VIN = 24V. Top trace (C4): Output voltage (200 mV/div.). Bottom trace (C3): Load current (10A/div.). C_0 470 μ F/70m Ω . Time: 1ms/div.

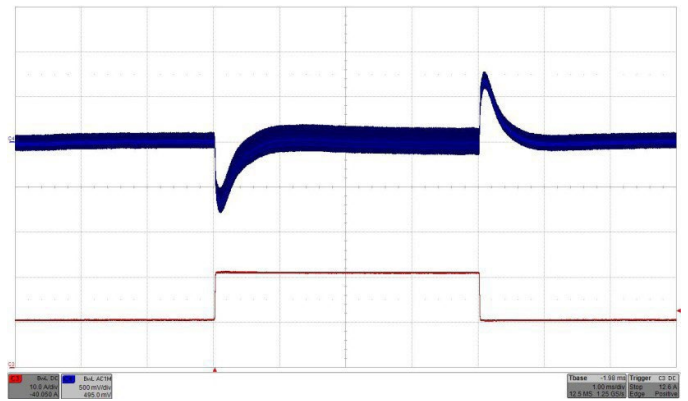

Fig. 25: Output voltage response to load current step change 50% - 100% - 50% (10.5A - 21A - 10.5A) with $di/dt = 1A/\mu s$ at VIN = 24V. Top trace (C4): Output voltage (500 mV/div.). Bottom trace (C3): Load current (10A/div.). C_0 470 μ F/70m Ω . Time: 1ms/div.

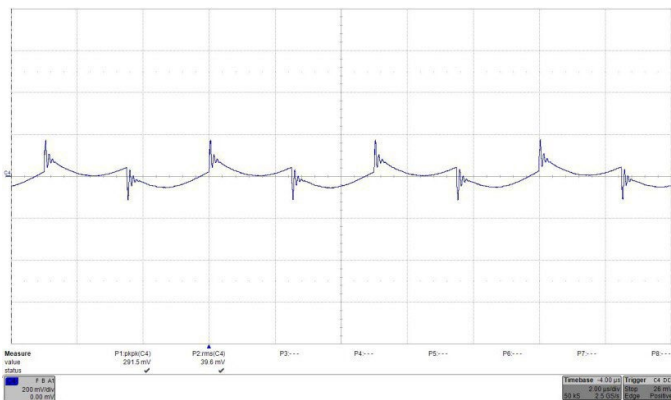

Fig. 26: Output voltage ripple (200mV/div.) at full rated load current into a resistive load at VIN = 24V. C_0 470 μ F/70m Ω . Time: 2 μ s/div.

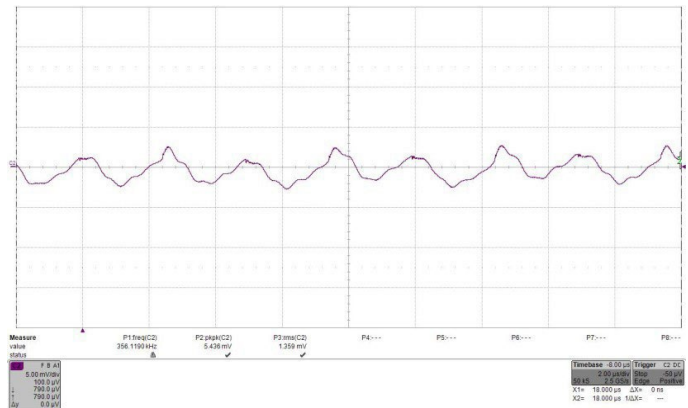

Fig. 27: Input reflected ripple current, i_c (500 mA/mV), measured at input terminals at full rated load current at VIN = 24V. Refer to Fig. 2 for test setup. Time: 2 μ s/div. RMS input ripple current is $1.359 \times 500\text{mA} = 679.5\text{mA}$.

Characteristic Waveforms – 24S28.18MXW (ROHS)

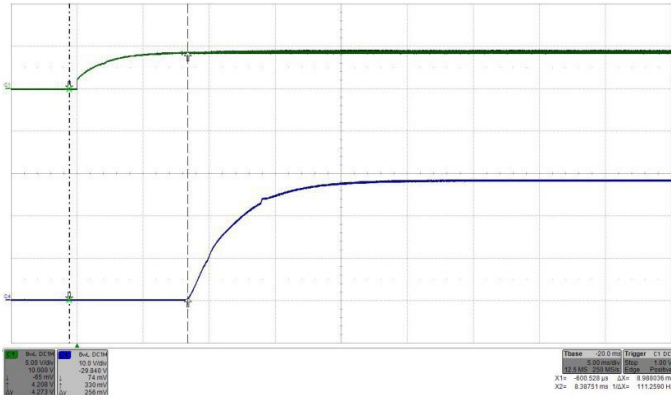

Fig. 28: Turn-on by ON/OFF transient (with VIN applied) at full rated load current (resistive) at VIN = 24V. Top trace (C1): ON/OFF signal (5V/div.). Bottom trace (C4): Output voltage (10 V/div.). Time 5 ms/div.

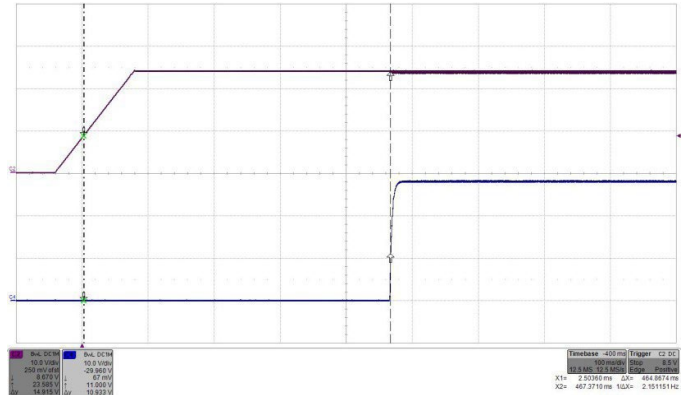

Fig. 29: Turn-on by VIN transient (ON/OFF high) at full rated load current (resistive) at VIN = 24V. Top trace (C2): Input voltage VIN (10 V/div.). Bottom trace (C4): Output voltage (10 V/div.). Time 100 ms/div.

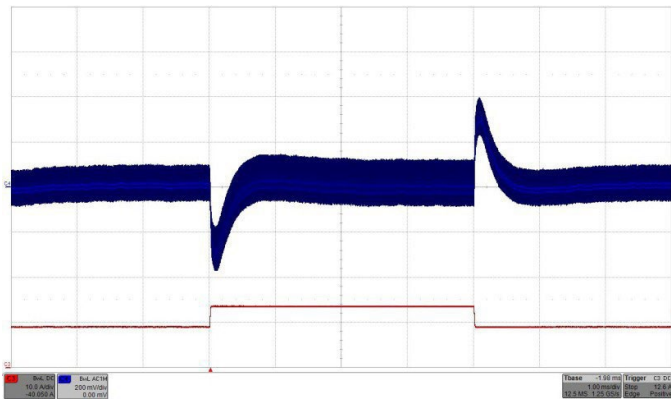

Fig. 30: Output voltage response to load current step change 50% - 75% - 50% (9A - 13.5A - 9A) with di/dt = 1A/μs at VIN = 24V. Top trace (C4): Output voltage (200 mV/div.). Bottom trace (C3): Load current (10A/div.). C₀ 470μF/70mΩ. Time: 1 ms/div.

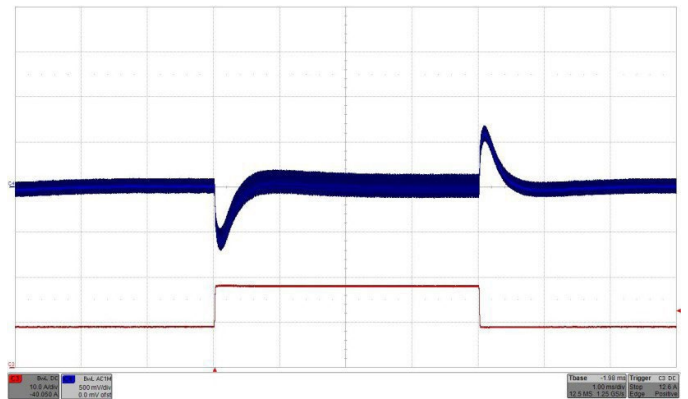

Fig. 31: Output voltage response to load current step change 50% - 100% - 50% (9A - 18A - 9A) with di/dt = 1A/μs at VIN = 24V. Top trace (C4): Output voltage (500 mV/div.). Bottom trace (C3): Load current (10A/div.). C₀ 470μF/70mΩ. Time: 1 ms/div.

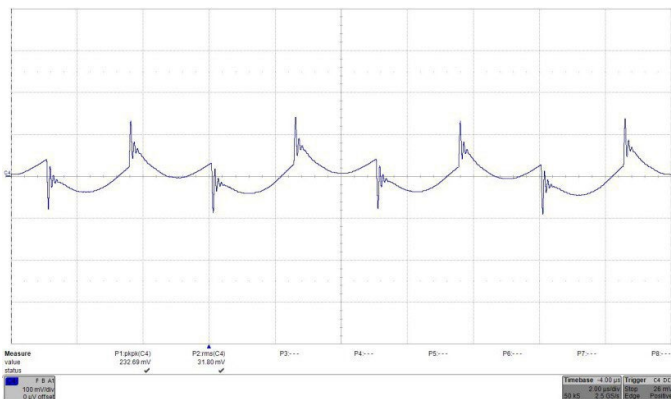

Fig. 32: Output voltage ripple (200mV/div.) at full rated load current into a resistive load at VIN = 24V. C₀ 470μF/70mΩ. Time: 2μs/div.

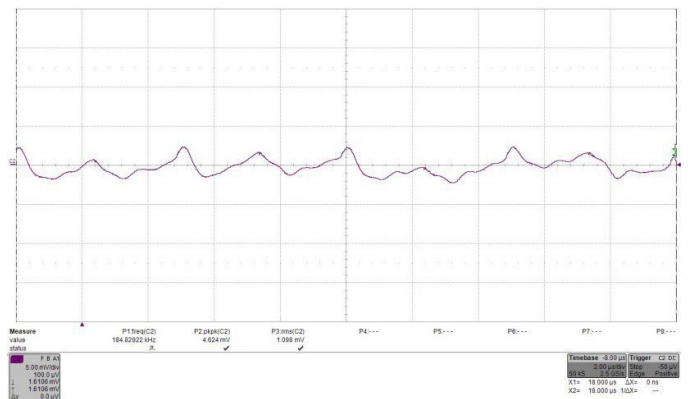
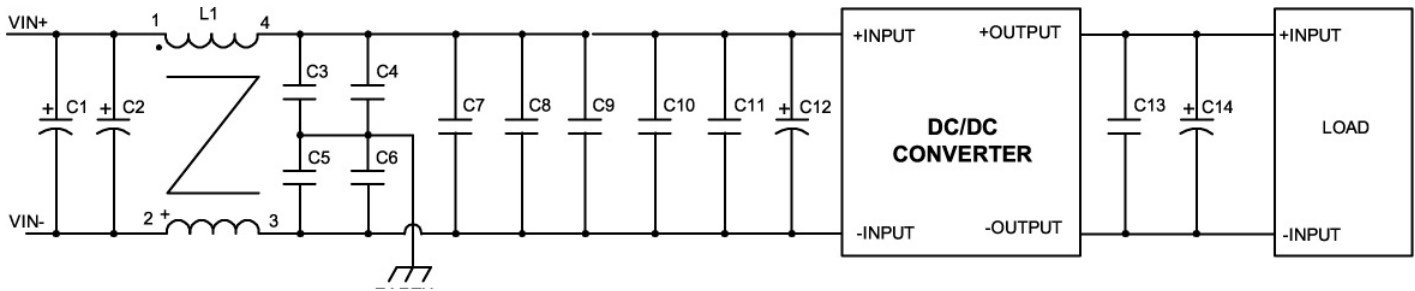

Fig. 33: Input reflected ripple current, i_c (500 mA/mV), measured at input terminals at full rated load current at VIN = 24V. Refer to Fig. 2 for test setup. Time: 2 μs/div. RMS input ripple current is $1.098 \times 500\text{mA} = 549\text{mA}$.

EMC Consideration:

The filter schematic for suggested input filter configuration as tested to meet the conducted emission limits of MIL-STD- 461F CE102 Base Curve is shown in Fig. 34. The plots of conducted EMI spectrum are shown in figure 35.

Note: Customer is ultimately responsible for the proper selection, component rating and verification of the suggested parts based on the end application.



| Comp. Des. | Description |
|---------------------------|--|
| C1, C2, C12, C14 | 470 μ F/50V/70m Ω Electrolytic Capacitor (Vishay MAL214699108E3 or equivalent) |
| C3, C4, C5, C6 | 4.7nF/1210/X7R/1500V Ceramic Capacitor |
| C7, C8, C9, C10, C11, C13 | 10 μ F/1210/X7R/50V Ceramic Capacitor |
| L1 | CM choke: L = 130 μ H, Llk = 0.6 μ H (4 turns on toroid 22.1 mm x 13.7mm x 7.92mm) |

Fig. 34: Typical input EMI filter circuit to attenuate conducted emissions per MIL-STD-461F CE102 Base Curve.

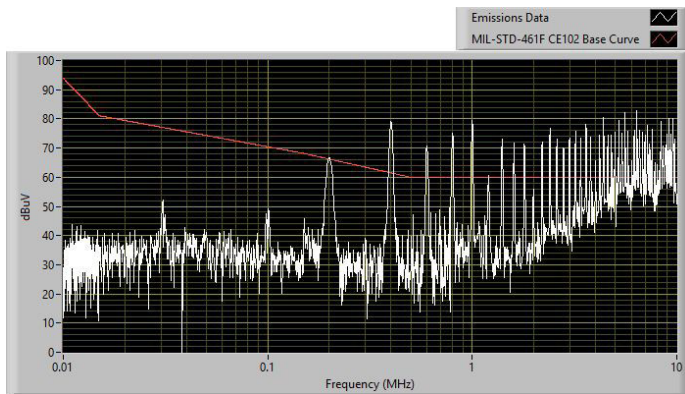

a) Without input filter. $C_{IN} = 2 \times 470\mu\text{F}/50\text{V}/70\text{m}\Omega$.

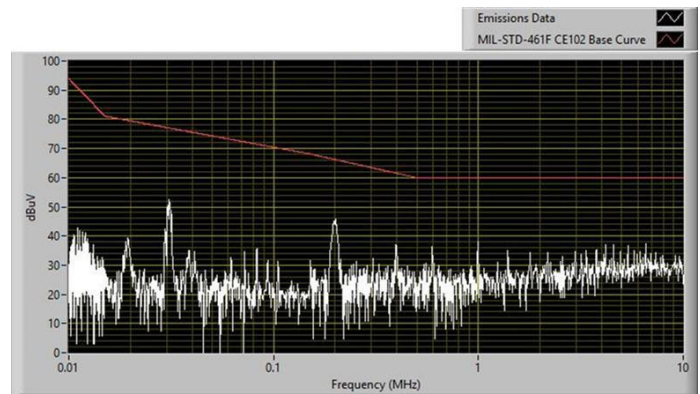

b) With input filter from Fig. 34.

Fig. 35: Input conducted emissions measurement (Typ.) of 24S24.21MXW (ROHS)

Mechanical Specification

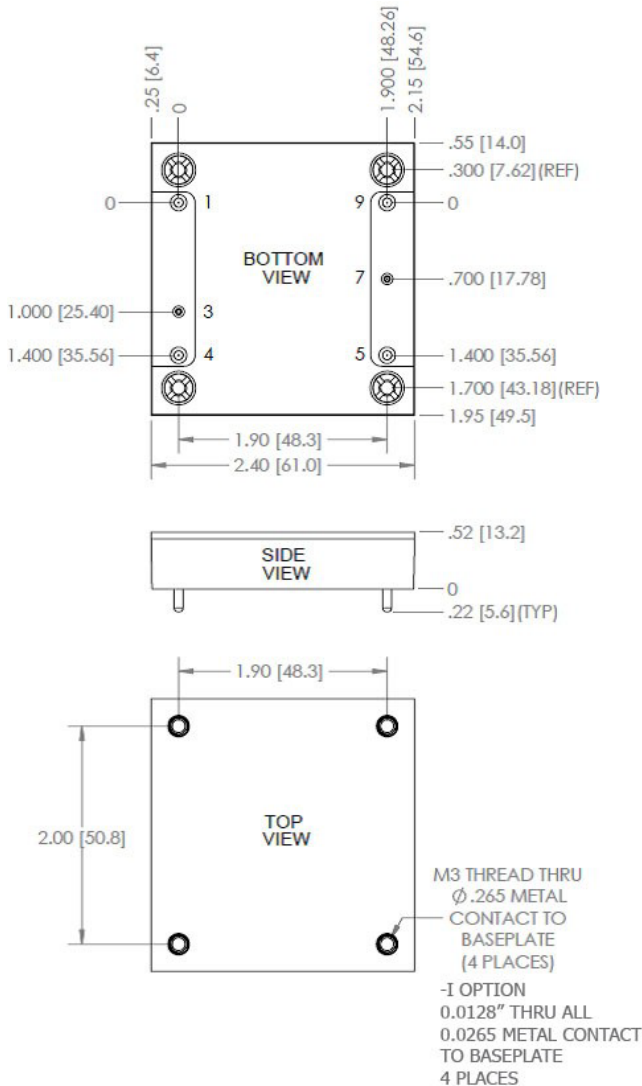

Input Output Connections:

| Pin | Name | Function |
|-----|---------|--|
| 1 | -INPUT | Negative input voltage |
| 3 | ON/OFF | TTL input with internal pull up, referenced to -INPUT, used to turn converter on and off |
| 4 | +INPUT | Positive input voltage |
| 5 | +OUTPUT | Positive output voltage |
| 7 | TRIM | Output voltage trim |
| 9 | -OUTPUT | Negative output voltage |

Notes:

Unless otherwise specified:

All dimensions are in inches [millimeters] Tolerances: x.xx in.
 ± 0.02 in [x.x mm ± 0.5 mm]

x.xxx in. ± 0.010 in [x.xx mm ± 0.25 mm]

Torque fasteners into threaded mounting inserts at 10in.lbs. or less. Greater torque may result in damage to unit and void the warranty.

Notes:

- 1) Pinout is inconsistent between manufacturers of the half brick converters. Make sure to follow the pin function, the pin number, when laying out your board.
- 2) Pin diameter for the input pins of the MXW converters has diameter 0.081" due to high current at low line and is different from other manufacturers of the half brick. Make sure to follow pin dimensions in your application.